

CS 59Pa

CS 59Pa



REYNAERS
aluminium

CS 59Pa



CS 59Pa (Fenster)

- 1 Feste Elemente
- 2 Öffnende Elemente
- 3 Kombinierte Elemente
- 4 Kombinationen in den Systemen

CS 59Pa (Türen)

- 5 Nach innen öffnend
- 6 Nach außen öffnend

CS 59Pa Front (CS 59Pa-Fr)

CS 59Pa Automatic Sliding Door (CS 59Pa-AD)

CS 59Pa Swing Door (CS 59Pa-SD)

CS 59Pa Clampable Door (CS 59Pa-CD)

CS 59Pa (Fenster)



1 Feste Elemente

Blendrahmen

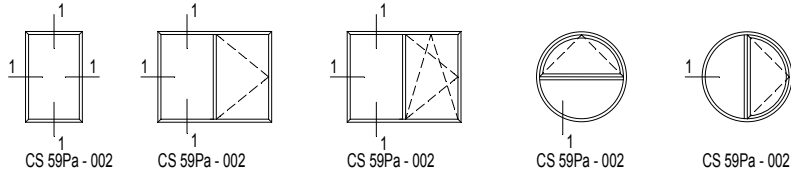

Rolladenführung

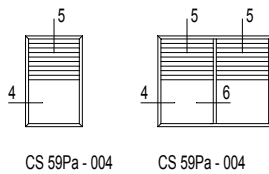

Wetterschenkel

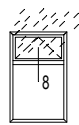
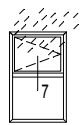

Verteilung in einem festen Fenster

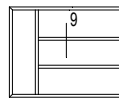

2 Öffnende Elemente

Nach innen öffnende Fenster

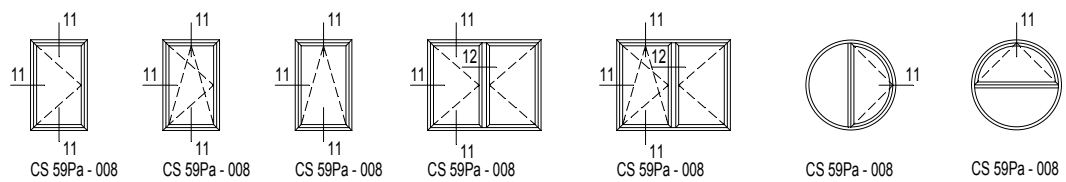

Verteilung im Flügel

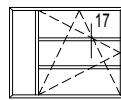
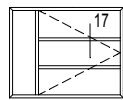

CS 59Pa



3 Kombinierte Elemente

Sprosse

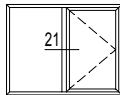

CS 59Pa - 012

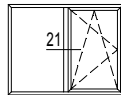

CS 59Pa - 012

Sprosse verstärkt

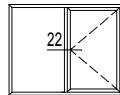

CS 59Pa - 015

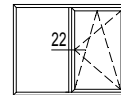

CS 59Pa - 015

Verstärkungsprofil

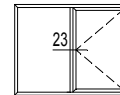

CS 59Pa - 016

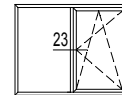

CS 59Pa - 016

Blendrahmen / Sprosse

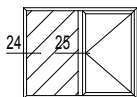

CS 59Pa - 020

Wechselprofil Außenverglasung

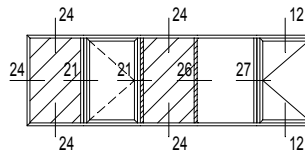

CS 59Pa - 023

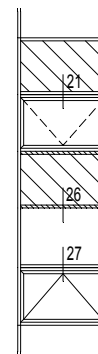

CS 59Pa - 023

4 Kombinationen in den Systemen

Im selben Bereich

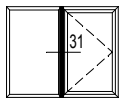

CS 59Pa - 024

Ausdehnung

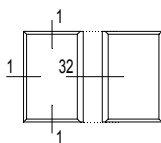

CS 59Pa - 025

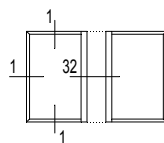

CS 59Pa - 025

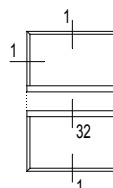

CS 59Pa - 025

Eckprofile

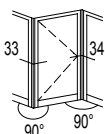

CS 59Pa - 026

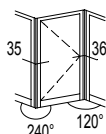

CS 59Pa - 028

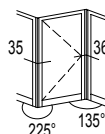

CS 59Pa - 028

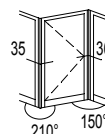

CS 59Pa - 028

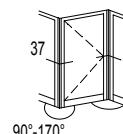

CS 59Pa - 029

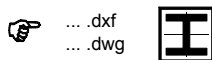
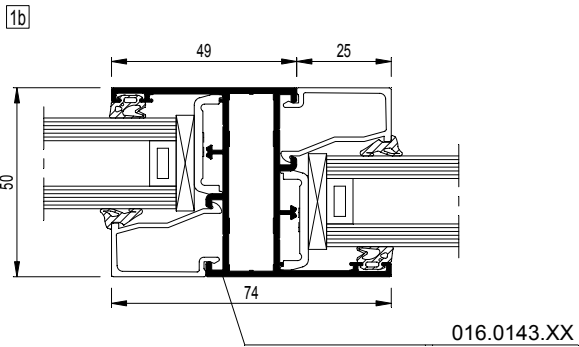
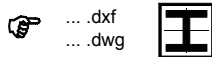
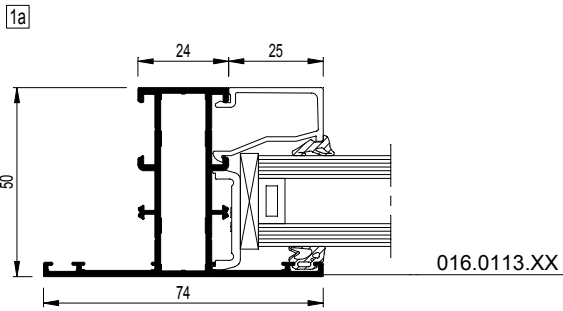
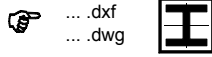
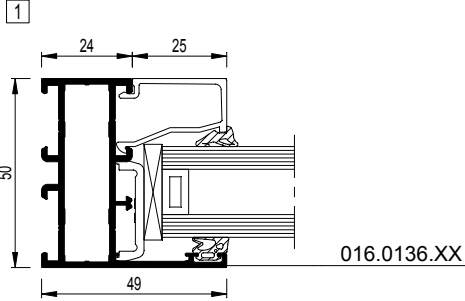
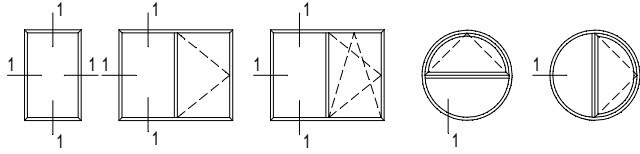

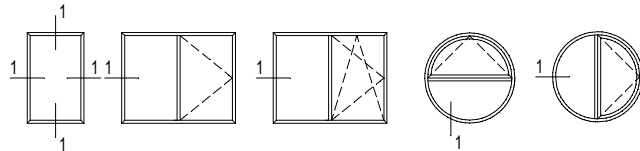

<p>016.0136.XX</p> <p>$I_x = 10.135 \text{ cm}^4$</p> <p>1 CS59Pa-001001.dxf CS59Pa-001001.dwg</p>	<p>016.0106.XX</p> <p>$I_x = 9.933 \text{ cm}^4$</p> <p>1 CS59Pa-001002.dxf CS59Pa-001002.dwg</p>	<p>016.0183.XX</p> <p>$I_x = 12.836 \text{ cm}^4$</p> <p>1 CS59Pa-001003.dxf CS59Pa-001003.dwg</p>	<p>016.0125.XX</p> <p>$I_x = 15.047 \text{ cm}^4$</p> <p>1 CS59Pa-001004.dxf CS59Pa-001004.dwg</p>
<p>016.0143.XX</p> <p>$I_x = 13.090 \text{ cm}^4$</p> <p>1 CS59Pa-001005.dxf CS59Pa-001005.dwg</p>			
<p>016.0113.XX</p> <p>$I_x = 11.786 \text{ cm}^4$</p> <p>1a CS59Pa-001006.dxf CS59Pa-001006.dwg</p>	<p>016.0120.XX</p> <p>$I_x = 14.610 \text{ cm}^4$</p> <p>1a CS59Pa-001007.dxf CS59Pa-001007.dwg</p>	<p>016.0114.XX</p> <p>$I_x = 16.886 \text{ cm}^4$</p> <p>1a CS59Pa-001008.dxf CS59Pa-001008.dwg</p>	
<p>016.0143.XX</p> <p>$I_x = 13.090 \text{ cm}^4$</p> <p>1b CS59Pa-001009.dxf CS59Pa-001009.dwg</p>	<p>016.0105.XX</p> <p>$I_x = 7.021 \text{ cm}^4$</p> <p>1b CS59Pa-001010.dxf CS59Pa-001010.dwg</p>		

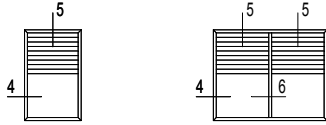

4

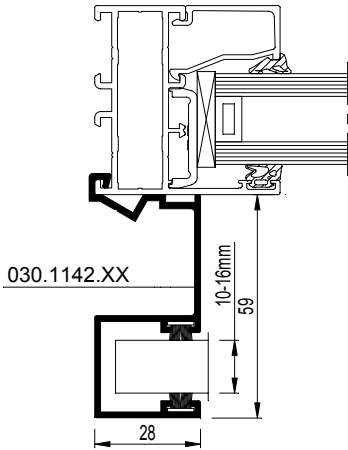

CS59Pa-004001.dxf
 CS59Pa-004001.dwg

5

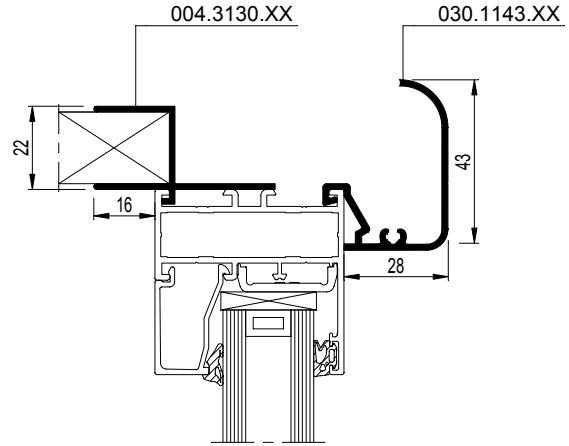

CS59Pa-005001.dxf
 CS59Pa-005001.dwg

5

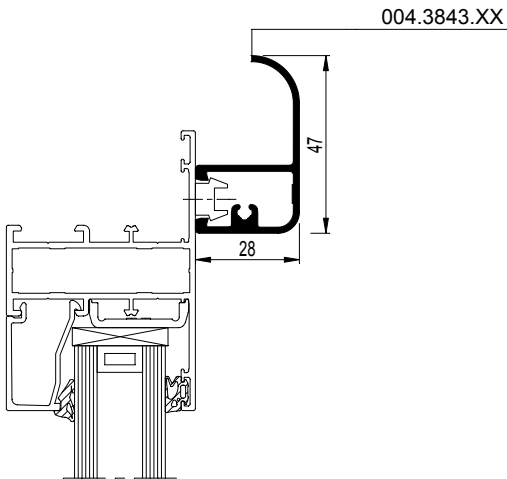

CS59Pa-005002.dxf
 CS59Pa-005002.dwg

CS 59Pa

Vaste elementen - Leklijst
Eléments fixes - Rejet d'eau
Fixed elements - Drip cap
Feste Elemente - Wetterschenkel

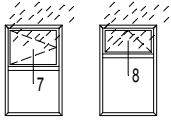

7

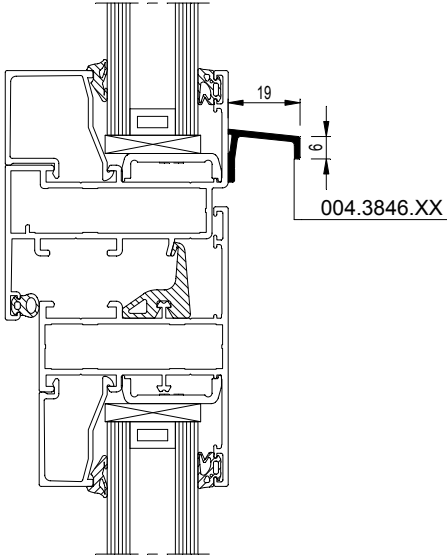

CS59Pa-007001.dxf
CS59Pa-007001.dwg

8

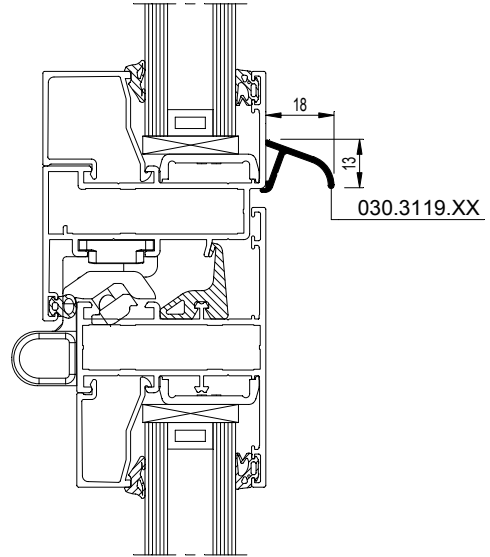

CS59Pa-008001.dxf
CS59Pa-008001.dwg

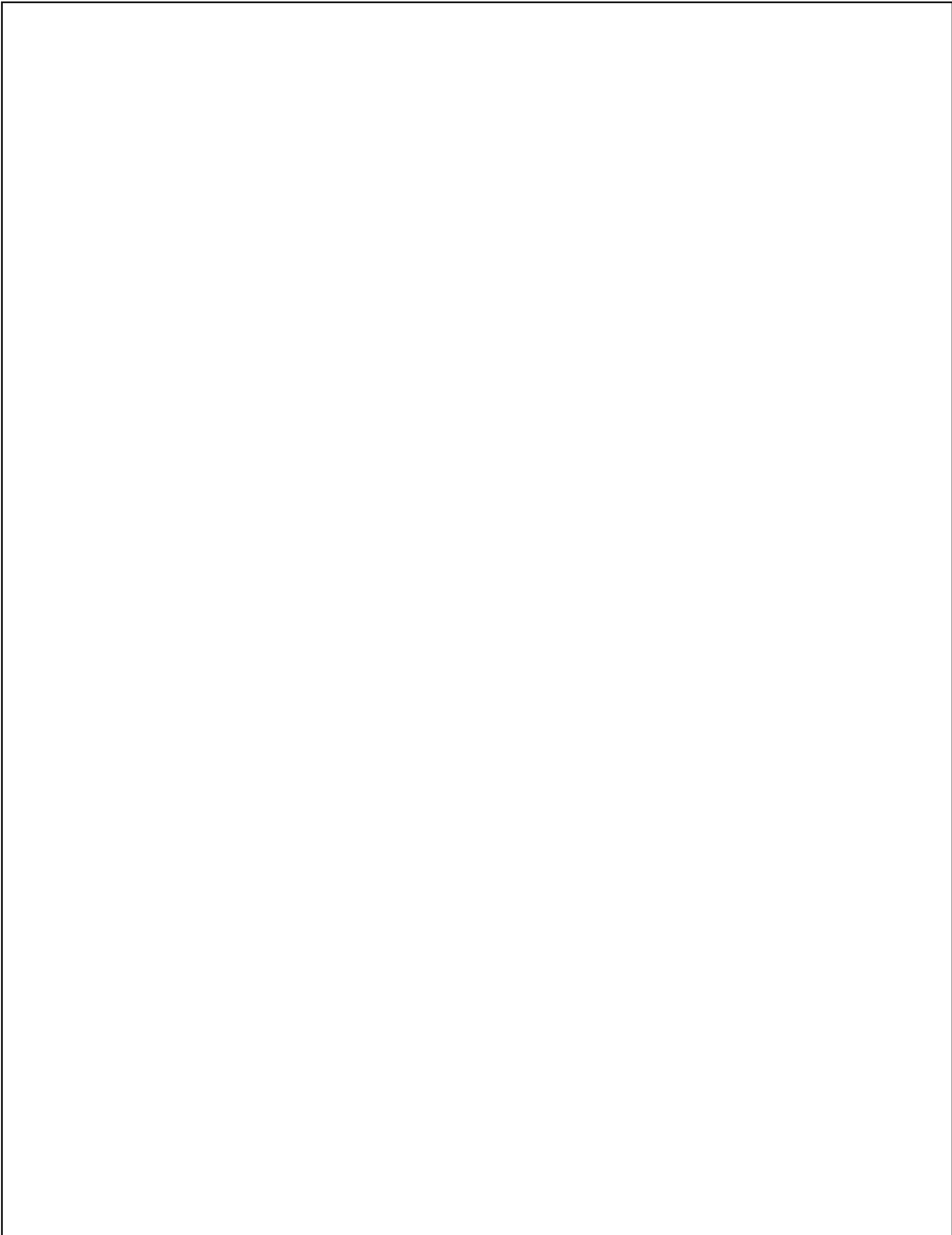



9

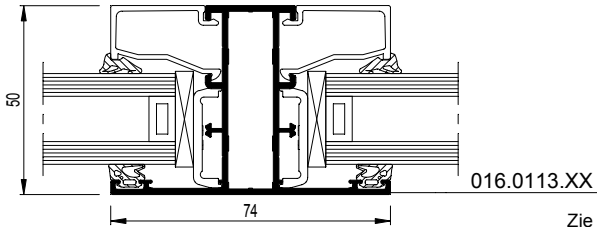

Zie ook T-profielen op blz. 12-13
Voir aussi traverses page 12-13
See also transom-mullions on pages 12-13
Siehe auch Sprossen Seite 12-13

CS59Pa-009003.dxf
CS59Pa-009003.dwg

9

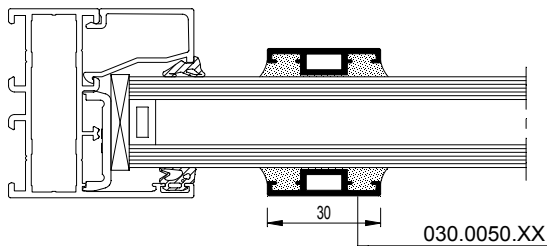

CS59Pa-009002.dxf
CS59Pa-009002.dwg

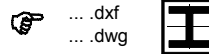
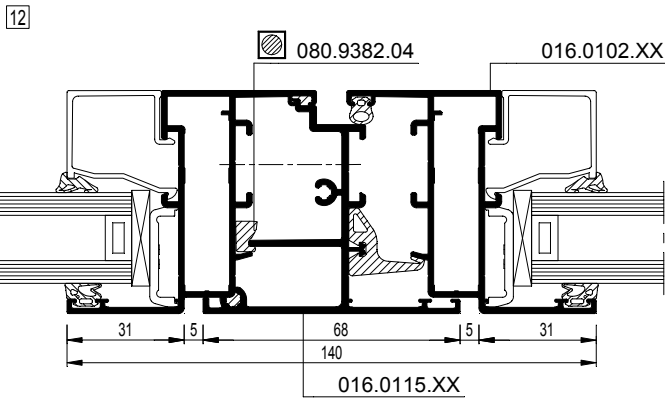
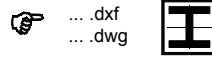
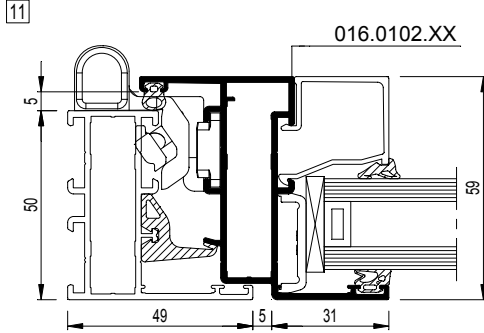
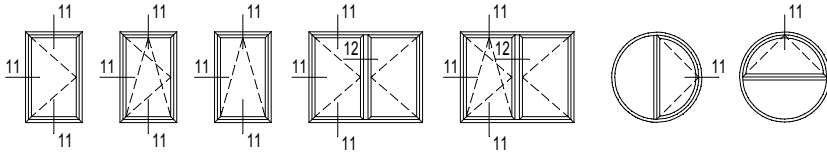

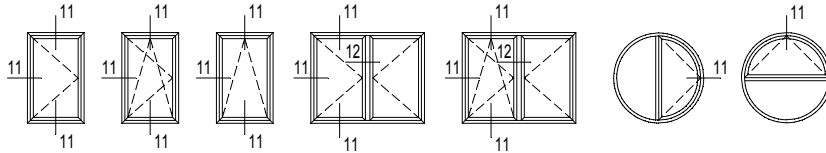

016.0102.XX

$I_x = 16.445 \text{ cm}^4$

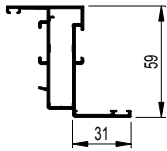

11

CS59Pa-011001.dxf
 CS59Pa-011001.dwg

12

CS59Pa-012001.dxf
 CS59Pa-012001.dwg

016.0192.XX

$I_x = 20.858 \text{ cm}^4$

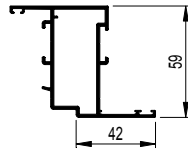

11

CS59Pa-011002.dxf
 CS59Pa-011002.dwg

12

CS59Pa-012002.dxf
 CS59Pa-012002.dwg

016.0121.XX

$I_x = 27.002 \text{ cm}^4$

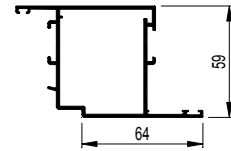

11

CS59Pa-011003.dxf
 CS59Pa-011003.dwg

12

CS59Pa-012003.dxf
 CS59Pa-012003.dwg

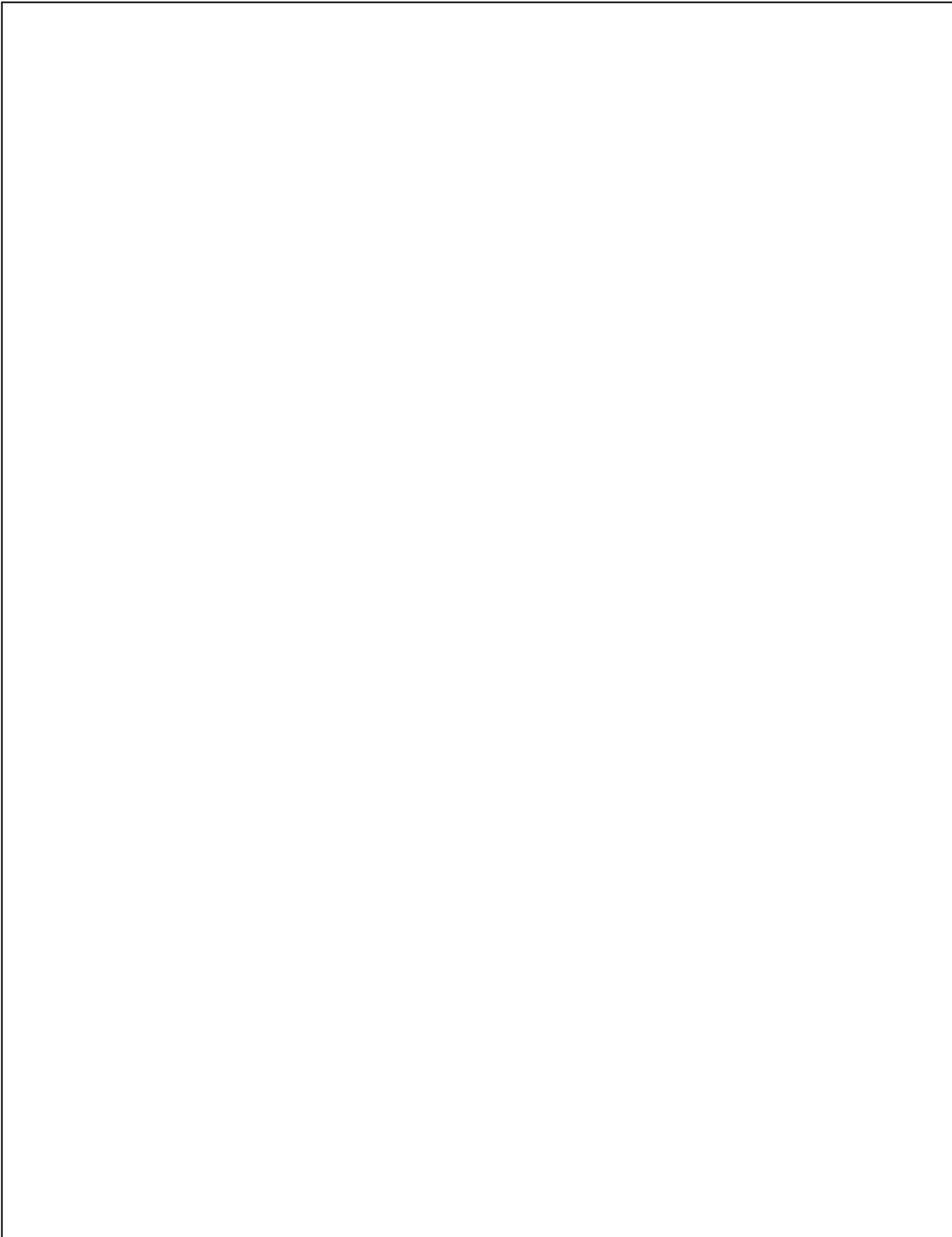

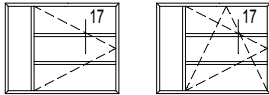

17

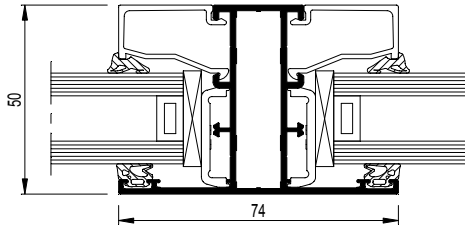

☞ Zie ook T-profielen op blz. 12-13
Voir aussi traverses page 12-13
See also transom-mullions on pages 12-13
Siehe auch Sprossen Seite 12-13

CS59Pa-017001.dxf
CS59Pa-017001.dwg

17

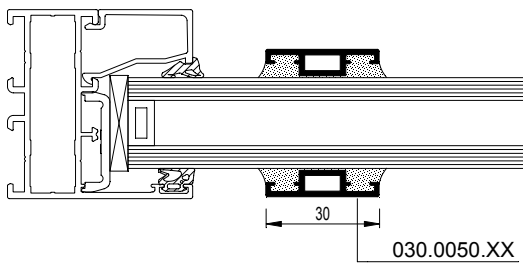

CS59Pa-017002.dxf
CS59Pa-017002.dwg

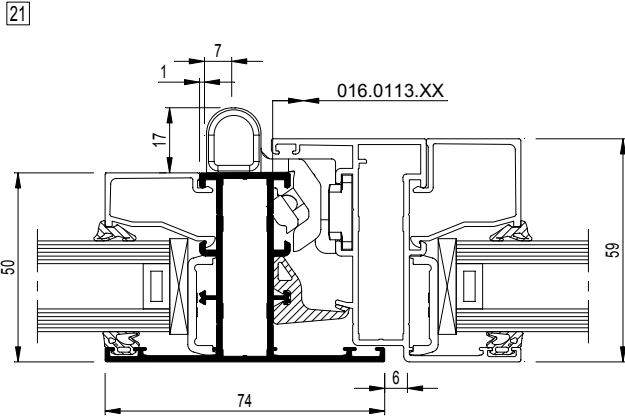
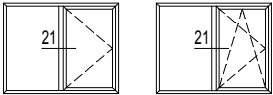

... .dxf
dwg



016.0113.XX

$I_x = 11.786 \text{ cm}^4$

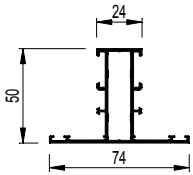

21 CS59Pa-021001.dxf
 CS59Pa-021001.dwg

016.0120.XX

$I_x = 14.610 \text{ cm}^4$

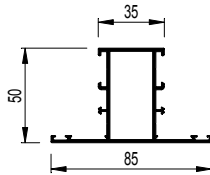

21 CS59Pa-021002.dxf
 CS59Pa-021002.dwg

016.0114.XX

$I_x = 16.886 \text{ cm}^4$

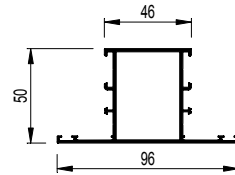

21 CS59Pa-021003.dxf
 CS59Pa-021003.dwg

016.0813.XX

$I_x = 13.054 \text{ cm}^4$

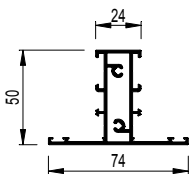

21 CS59Pa-021004.dxf
 CS59Pa-021004.dwg

016.0820.XX

$I_x = 15.700 \text{ cm}^4$

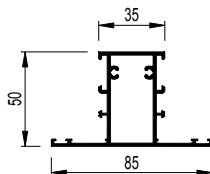

21 CS59Pa-021005.dxf
 CS59Pa-021005.dwg

016.0814.XX

$I_x = 17.934 \text{ cm}^4$

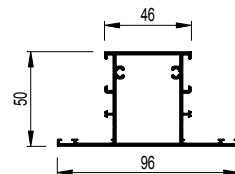

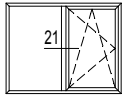
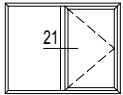

21 CS59Pa-021006.dxf
 CS59Pa-021006.dwg

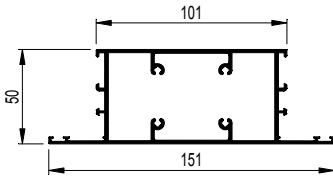

016.0817.XX

$I_x = 33.870 \text{ cm}^4$



 CS59Pa-021007.dxf
CS59Pa-021007.dwg

016.0847.XX

$I_x = 36.435 \text{ cm}^4$

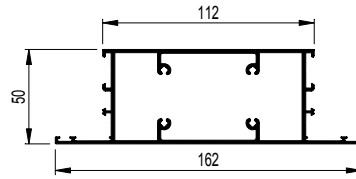

 CS59Pa-021008.dxf
CS59Pa-021008.dwg

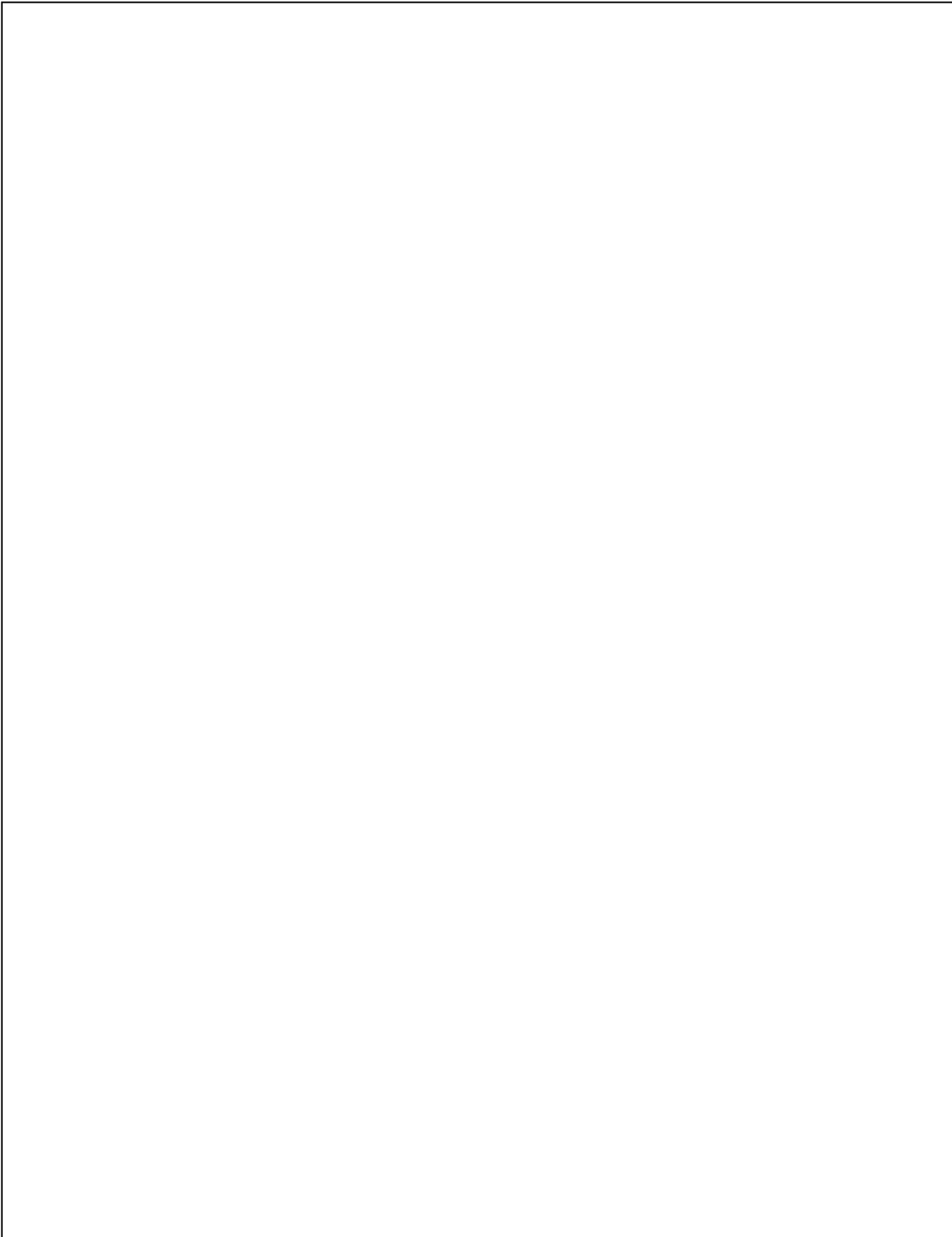

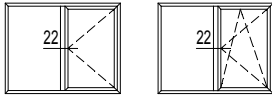

22

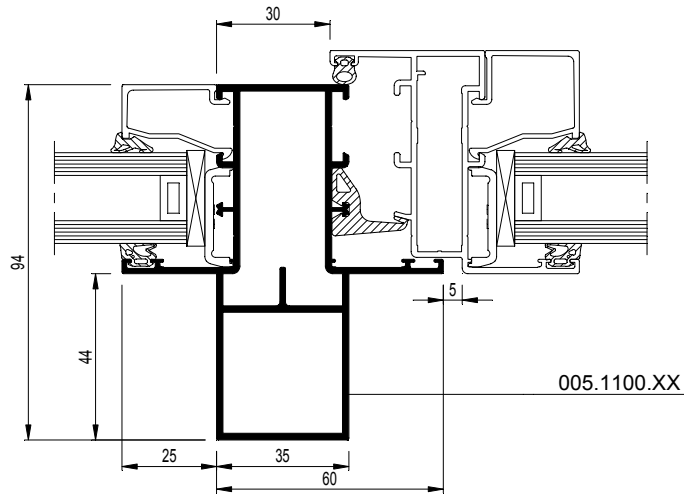

CS59Pa-022001.dxf
CS59Pa-022001.dwg

Eindstukken beschikbaar
Pièces finales disponibles
End caps available
Endstücke verfügbar

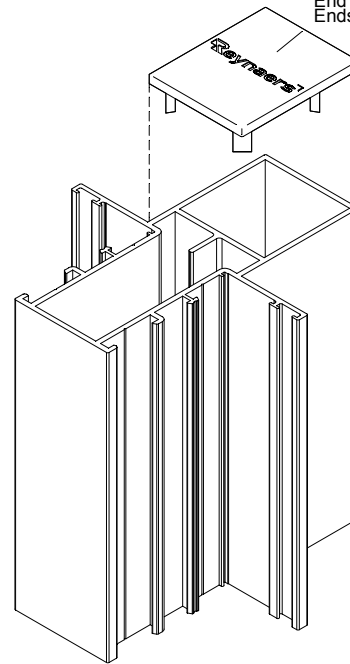

CS59Pa-3d0002.dxf
CS59Pa-3d0002.dwg

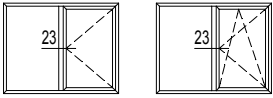

23a

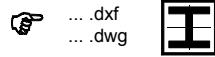
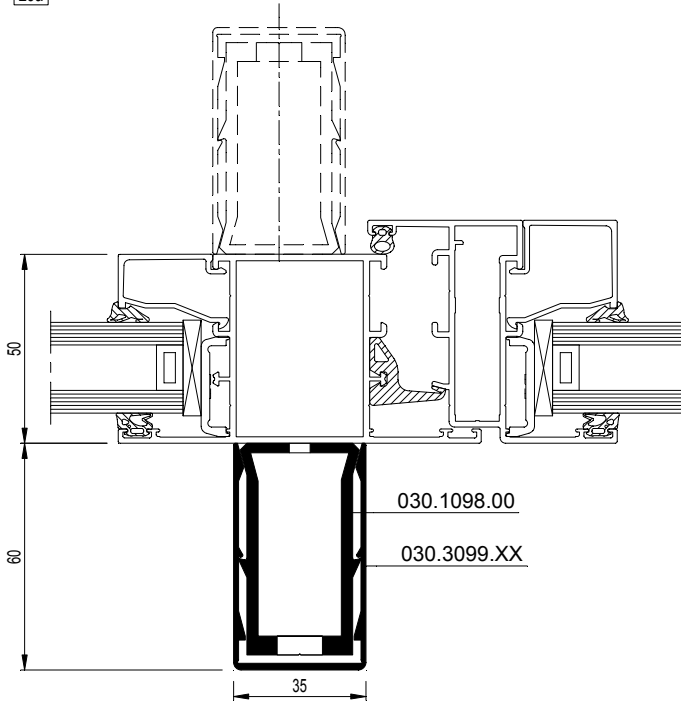

23

Nota : voor keuze van versteviging : zie waarden op blz 18-19
 Note : pour choix de renforcement : voir valeurs page 18-19
 Note : For choice of reinforcement, see values on pages 18-19
 Note : für Verstärkungswahl : siehe Werte Seite 18-19

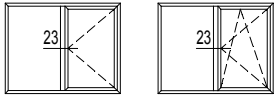

030.1098.00

$I_x = 19.656 \text{ cm}^4$



23

CS59Pa-023003.dxf
 CS59Pa-023003.dwg

030.3099.XX

$I_x = 9.625 \text{ cm}^4$

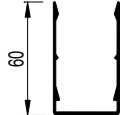

030.1097.00

$I_x = 10.260 \text{ cm}^4$



23

CS59Pa-023004.dxf
 CS59Pa-023004.dwg

030.3099.XX

$I_x = 9.625 \text{ cm}^4$

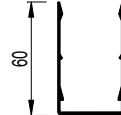

030.1096.00

$I_x = 4.881 \text{ cm}^4$



23

CS59Pa-023005.dxf
 CS59Pa-023005.dwg

030.3097.XX

$I_x = 2.767 \text{ cm}^4$



Opmerking: - Versteviging van binnenzijde + scharnier is niet mogelijk indien de binnenzijde van een T-profiel < 75 mm

- Bevestiging: om de 300 mm
- Bij horizontale versteviging, contacteer Reynaers Consult



Remarque: - Positionnement du renfort à l'intérieur en présence de charnières non possible sur profilé-T de largeur intérieure < 75 mm

- Fixation: tous les 300 mm
- Pour utilisation comme renfort horizontal, contactez Reynaers Consult

Remark: - Reinforcement of inner side + hinge is not possible in case the inner side of a transom-mullion < 75 mm Fixing: every 300 mm

- For horizontal reinforcements, please contact Reynaers Consult - tel. 015/30 88 99

Anmerkung: - Verstärkung der Innenseite und Band ist unmöglich wenn die Innenseite einer Sprosse < 75 mm

- Bevestiging: jede 300 mm
- Bei horizontaler Verstärkung, bitte nehmen Sie Kontakt auf mit Reynaers Consult

		i Versteviging langs binnen Renforcement du côté intérieur Reinforcement inside Verstärkung der Innenseite		e Versteviging langs buiten Renforcement du côté extérieur Reinforcement outside Verstärkung der Aussenseite			
T-profiel Traverse Transom-mullion Sprosse	Zonder versteviging Sans renforcement Without reinforcement Ohne Verstärkung	met avec with mit	030.1097.00	met avec with mit	030.1098.00		
	Ix cm4	Wx cm3		Ix cm4	Wx cm3	Ix cm4	Wx cm3
016.0113.XX 	11.786	3.797	e	49.41	9.51	74.92	12.44
016.0120.XX 	14.610	4.834	e	55.16	10.38	83.16	14.31
			i	72.27	12.26	107.10	20.05
016.0114.XX 	16.886	5.668	e	61.71	10.96	88.66	15.61
			i	75.40	12.59	111.67	20.80

Opmerking: - Versterking van binnenzijde + scharnier is niet mogelijk indien de binnenzijde van een T-profiel < 75 mm breedte is.
- Bevestiging: om de 300 mm
- Bij horizontale versterking, contacteer Reynaers Consult



Remarque: - Positionnement du renfort à l'intérieur en présence de charnières non possible sur profilé-T de largeur intérieure < 75 mm
- Fixation: tous les 300 mm
- Pour utilisation comme renfort horizontal, contactez Reynaers Consult

Remark: - Reinforcement of inner side + hinge is not possible in case the inner side of a transom-mullion < 75 mm
- For horizontal reinforcements, please contact Reynaers Consult - tel. 015/30 88 99

Anmerkung: - Verstärkung der Innenseite und Band ist unmöglich wenn die Innenseite einer Sprosse < 75 mm
- Bevestigung: jede 300 mm
- Bei horizontaler Verstärkung, bitte nehmen Sie Kontakt auf mit Reynaers Consult

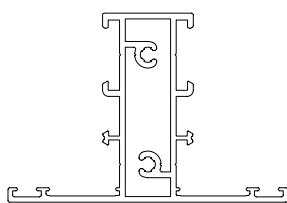
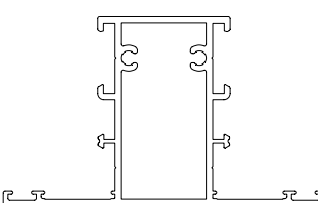
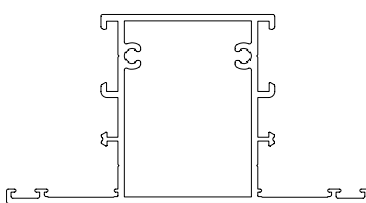
 T-profiel Sprosse Transom-mullion Traverse	Zonder versterking Sans renforcement Without reinforcement Ohne Verstärkung			met avec with mit 030.1097.XX		met avec with mit 030.1098.XX	
	Ix cm4	Wx cm3	e	Ix cm4	Wx cm3	Ix cm4	Wx cm3
016.0813.XX 	13.054	4.298	e i	53.32	10.09	81.00	13.88
016.0820.XX 	15.700	5.437	e i	59.26	10.83	89.20	15.77
016.0814.XX 	17.934	6.276	e i	62.97	11.29	94.39	17.05

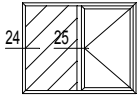

24

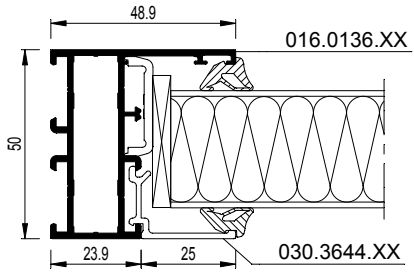

☞dxf
... .dwg



25

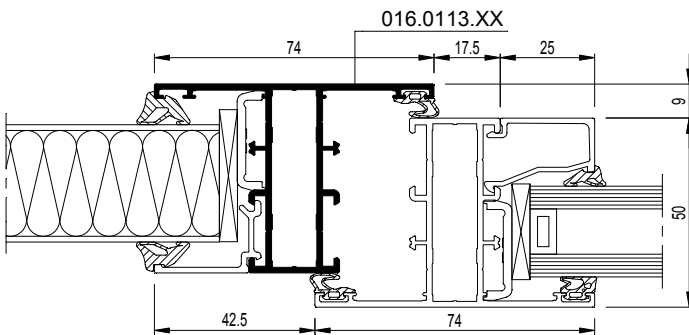

☞dxf
... .dwg





016.0136.XX

$I_x = 10.135 \text{ cm}^4$

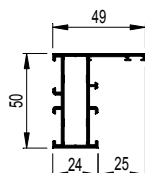

 CS59Pa-024001.dxf
 CS59Pa-024001.dwg

016.0183.XX

$I_x = 12.836 \text{ cm}^4$

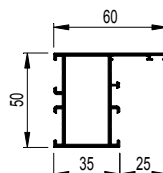

 CS59Pa-024002.dxf
 CS59Pa-024002.dwg

016.0125.XX

$I_x = 15.047 \text{ cm}^4$

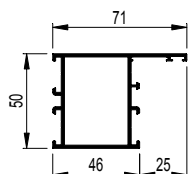

 CS59Pa-024003.dxf
 CS59Pa-024003.dwg

016.0113.XX

$I_x = 11.786 \text{ cm}^4$

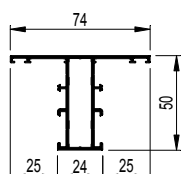

 CS59Pa-025001.dxf
 CS59Pa-025001.dwg

016.0120.XX

$I_x = 14.610 \text{ cm}^4$

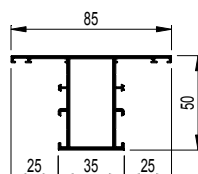

 CS59Pa-025002.dxf
 CS59Pa-025002.dwg

016.0114.XX

$I_x = 16.886 \text{ cm}^4$

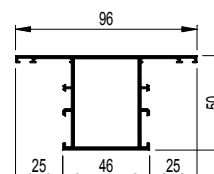

 CS59Pa-025003.dxf
 CS59Pa-025003.dwg

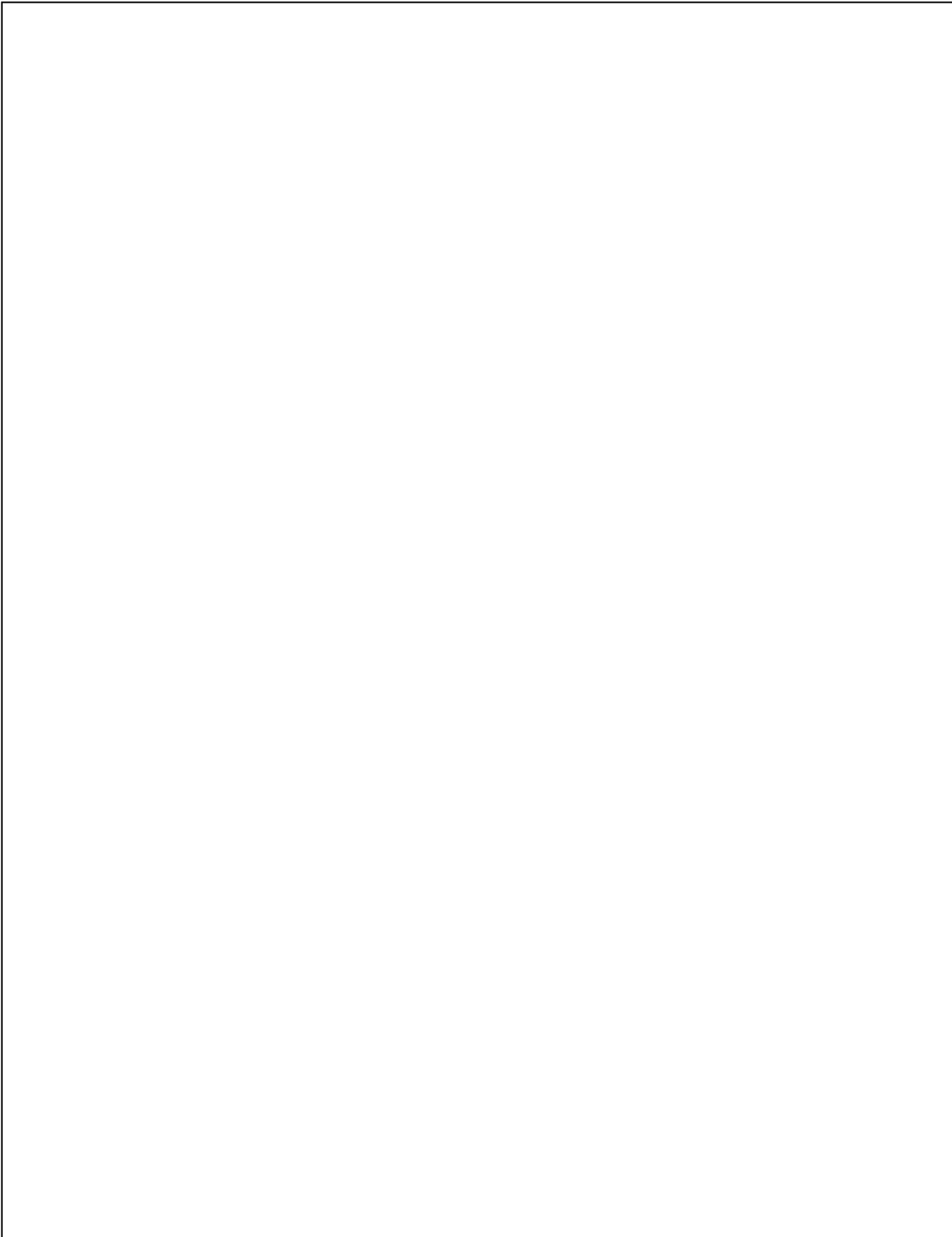

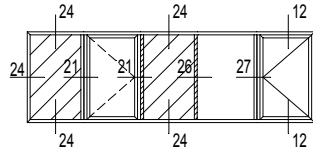

26

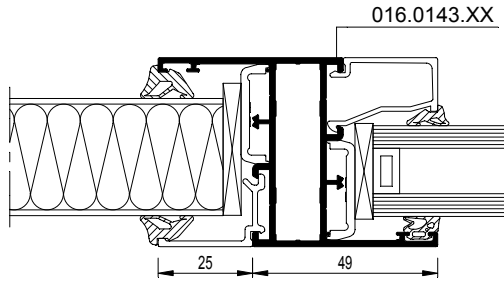

... .dxf
dwg



27

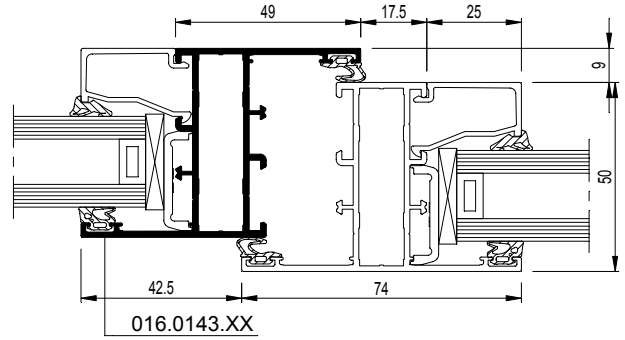

... .dxf
dwg



016.0143.XX

$I_x = 13.090 \text{ cm}^4$

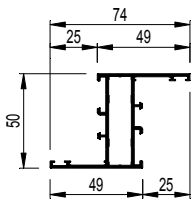

- 26 CS59Pa-026001.dxf
 CS59Pa-026001.dwg
- 27 CS59Pa-027001.dxf
 CS59Pa-027001.dwg

016.0105.XX

$I_x = 7.021 \text{ cm}^4$

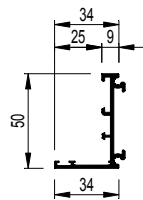

- 26 CS59Pa-026002.dxf
 CS59Pa-026002.dwg
- 27 CS59Pa-027002.dxf
 CS59Pa-027002.dwg

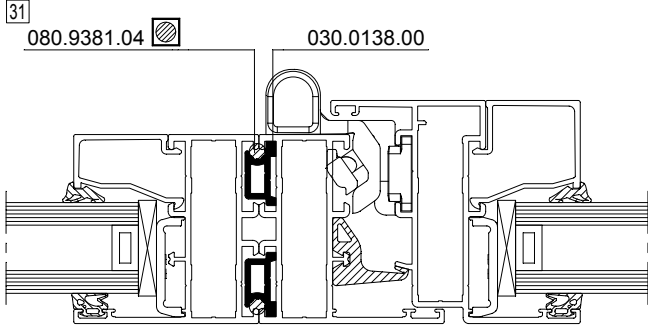
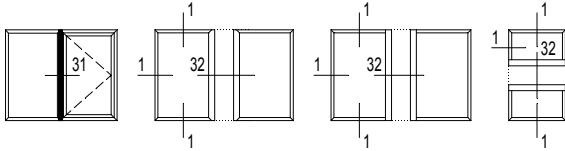

CS59Pa-031001.dxf
 CS59Pa-031001.dwg

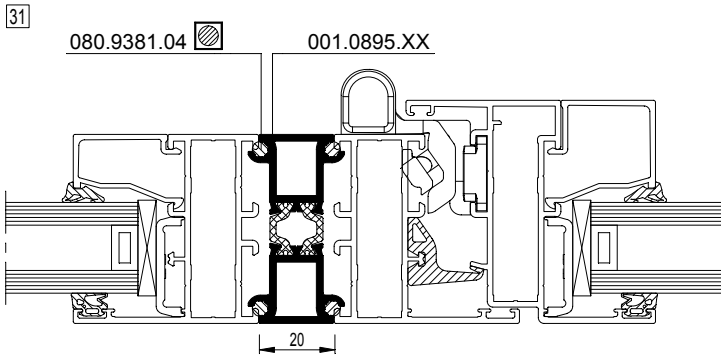

001.0895.XX

$I_x = 7.010 \text{ cm}^4$

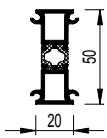

CS59Pa-031002.dxf
 CS59Pa-031002.dwg

005.1848.XX

$I_x = 90.907 \text{ cm}^4$

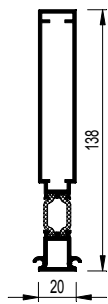

CS59Pa-031004.dxf
 CS59Pa-031004.dwg

006.0371.XX

$I_x = 120.097 \text{ cm}^4$

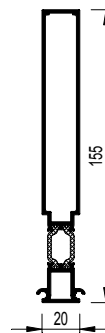

CS59Pa-031005.dxf
 CS59Pa-031005.dwg

005.1837.XX

$I_x = 58.021 \text{ cm}^4$

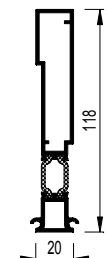

CS59Pa-031003.dxf
 CS59Pa-031003.dwg

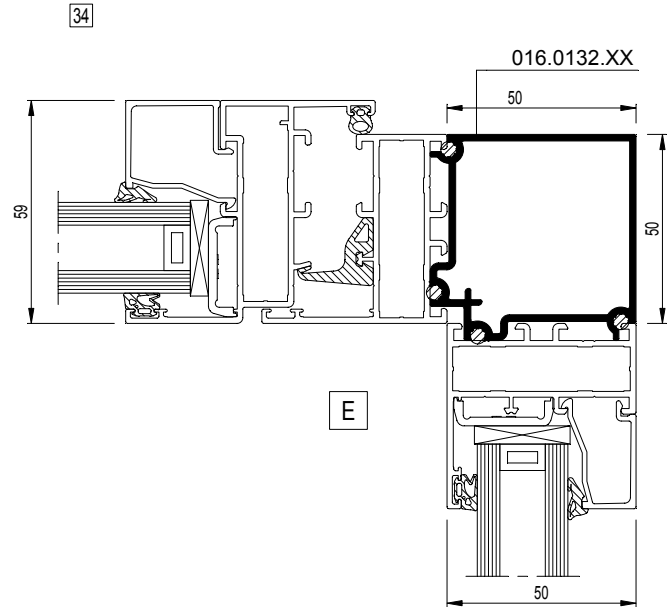
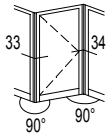

CS59Pa-034001.dxf
 CS59Pa-034001.dwg

33

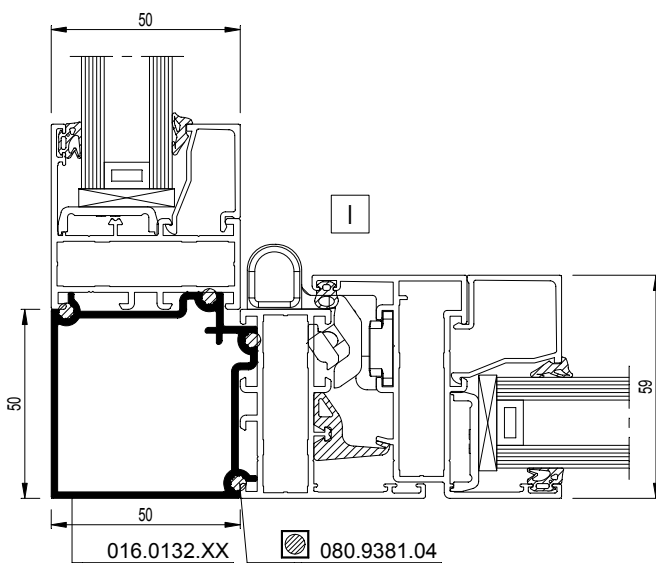

CS59Pa-033001.dxf
 CS59Pa-033001.dwg

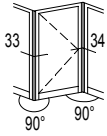

33

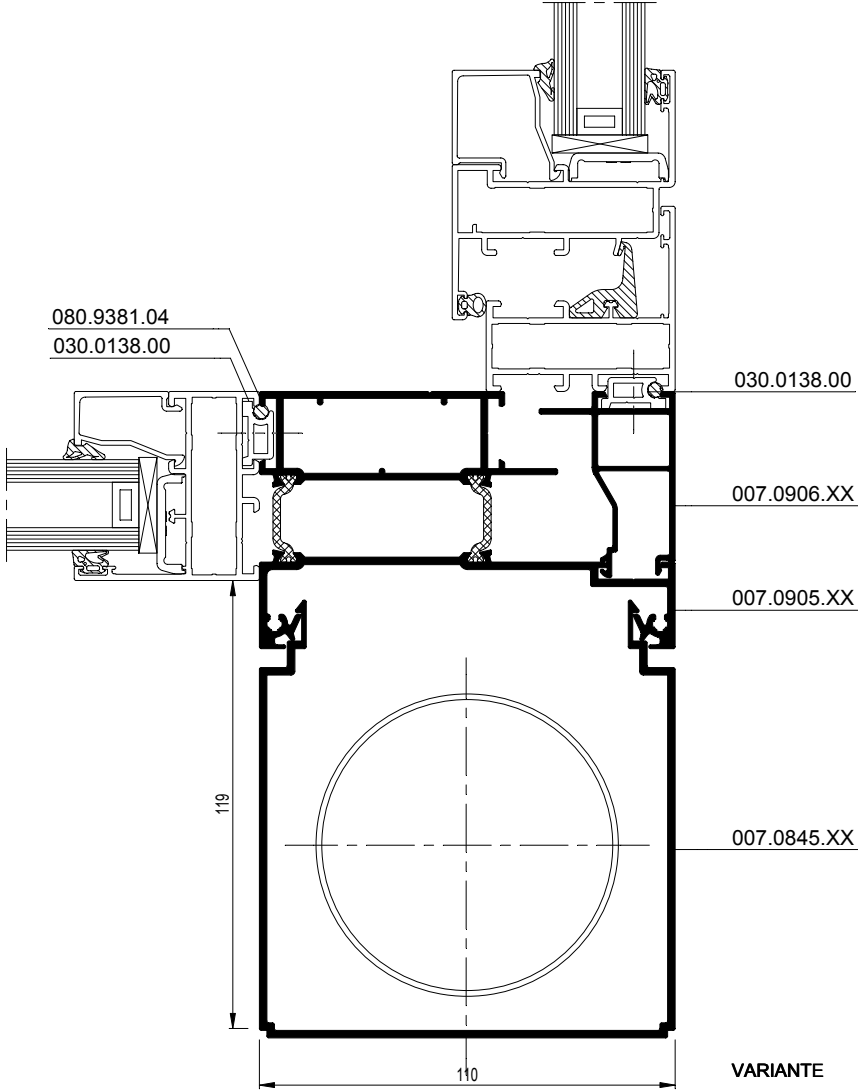

CS59Pa-033002.dxf
CS59Pa-033002.dwg

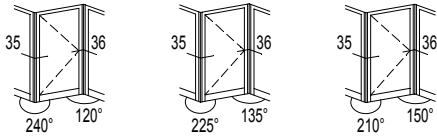

36

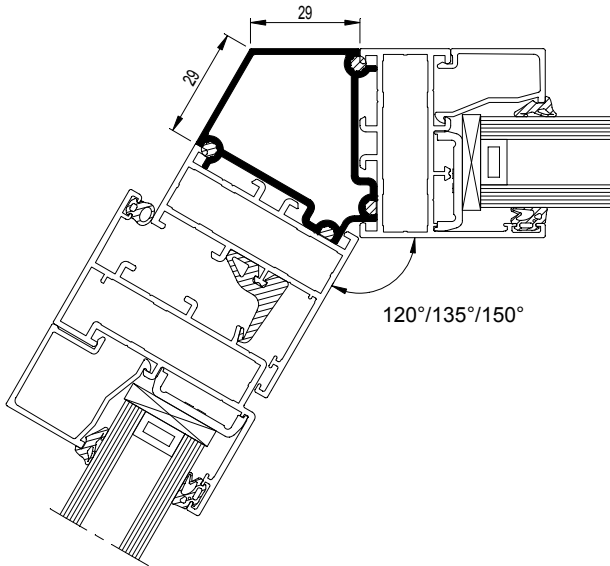

35

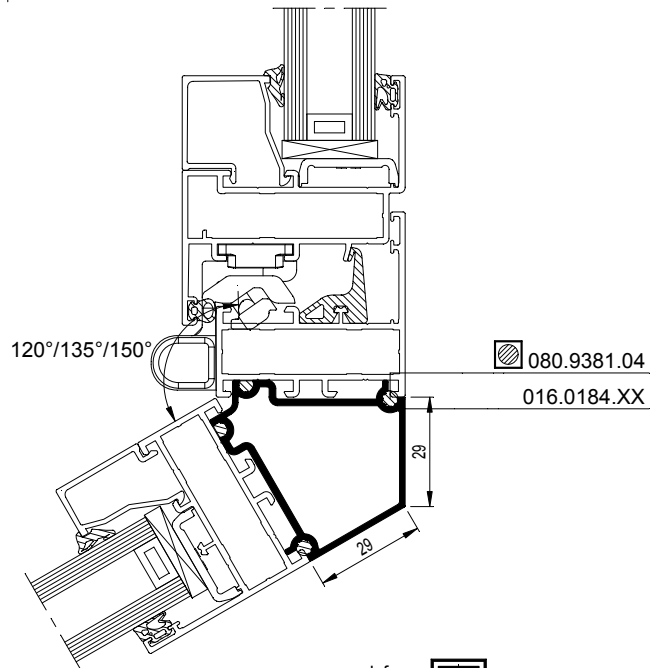

☞dxf
dwg

☞dxf
dwg

016.0184.XX

$I_x = 7.785 \text{ cm}^4$

120°

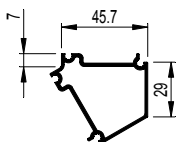

35 CS59Pa-035001.dxf
 CS59Pa-035001.dwg

36 CS59Pa-036001.dxf
 CS59Pa-036001.dwg

016.0178.XX

$I_x = 6.505 \text{ cm}^4$

135°

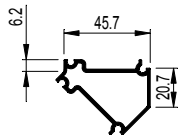

35 CS59Pa-035002.dxf
 CS59Pa-035002.dwg

36 CS59Pa-036002.dxf
 CS59Pa-036002.dwg

016.0179.XX

$I_x = 2.119 \text{ cm}^4$

150°

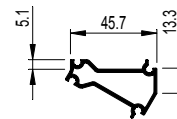

35 CS59Pa-035003.dxf
 CS59Pa-035003.dwg

36 CS59Pa-036003.dxf
 CS59Pa-036003.dwg

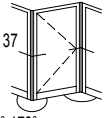

90°-170°

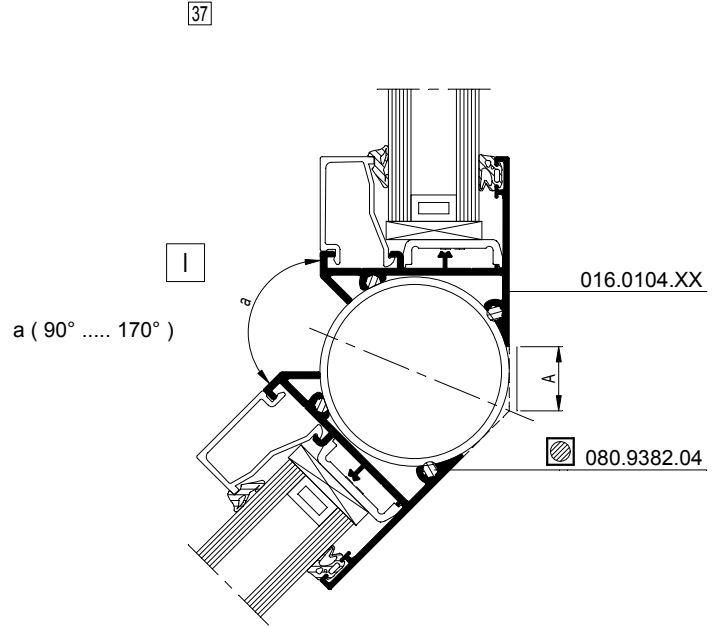

CS59Pa-037001.dxf
 CS59Pa-037001.dwg

a	A
170°	8.8
160°	11
150°	13.3
140°	15.8
130°	18.3
120°	21.1
110°	24.2
100°	27.7
90°	31.7

CS 59Pa (Türen)



5 Türen nach innen öffnend

Nach innen öffnende Türen

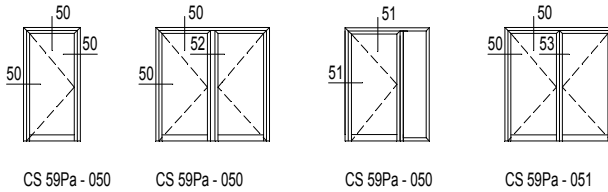

... mit Fensterprofil

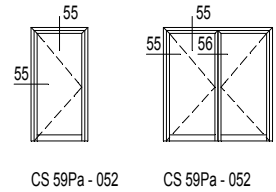

Nach innen öffnende Türen mit rundherum gepresstem Türflügel

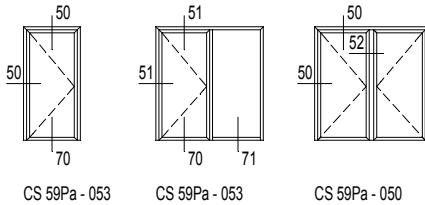

... mit Fensterprofil

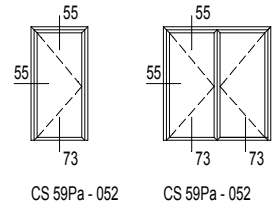

Türen mit T-profilsockel

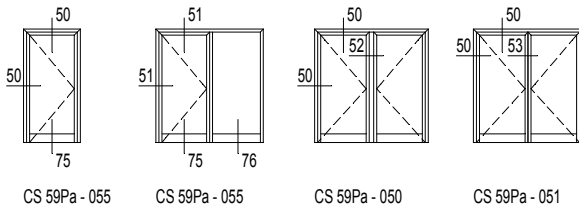

6 Türen nach außen öffnend

Nach außen öffnende Türen

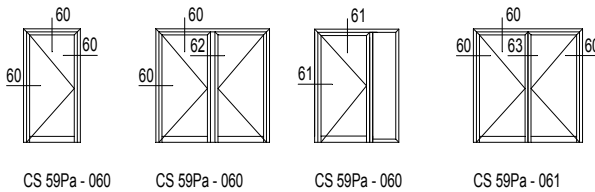

Nach außen öffnende Türen mit rundherum gepresstem Türflügel

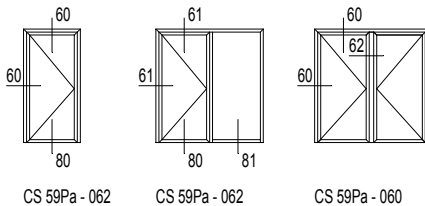

Türen mit T-profilsockel

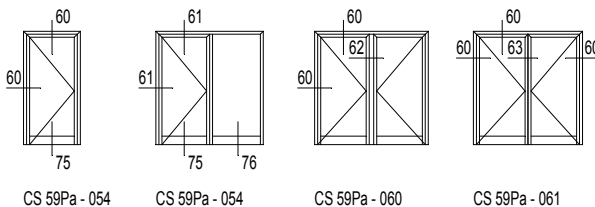

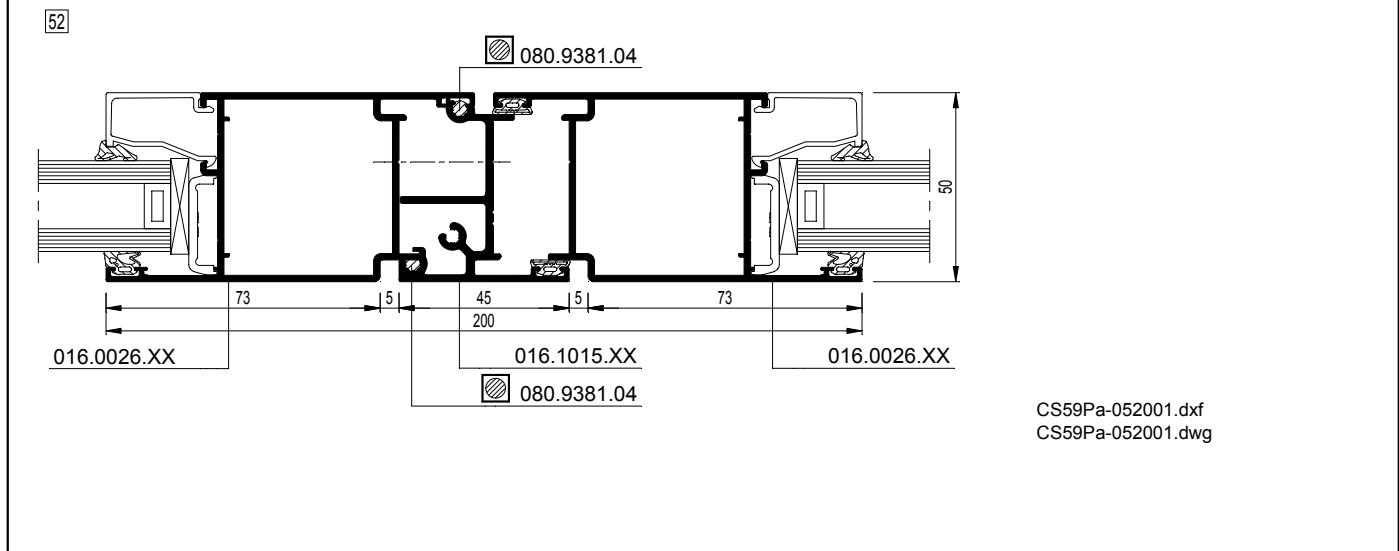
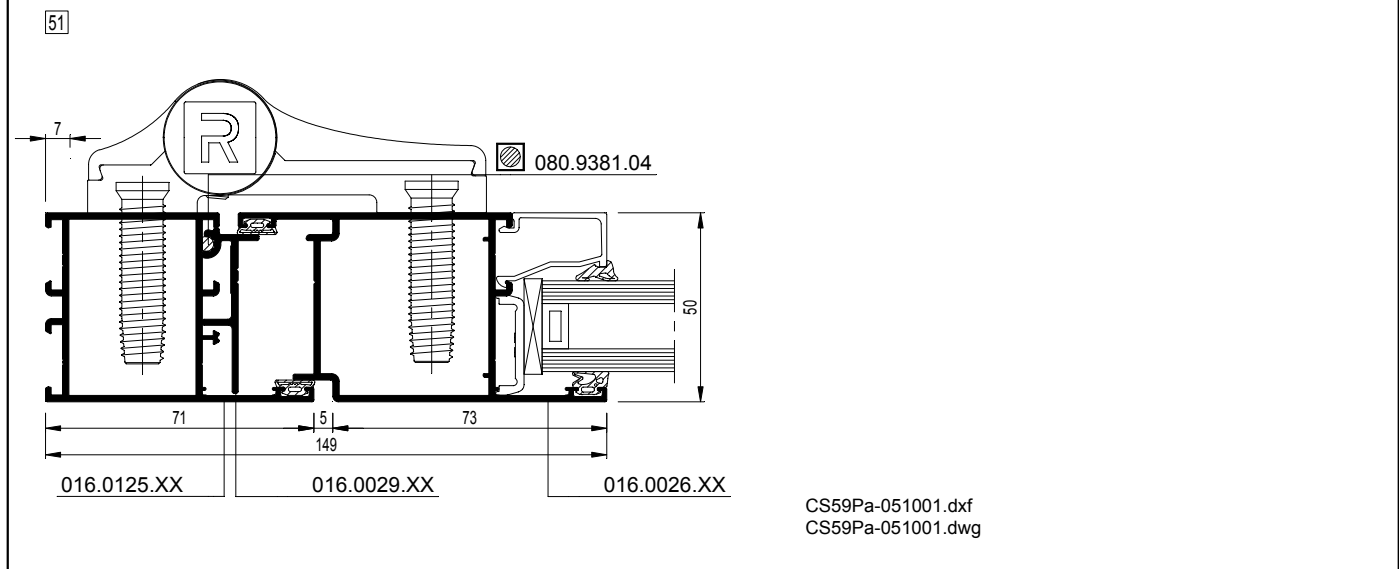
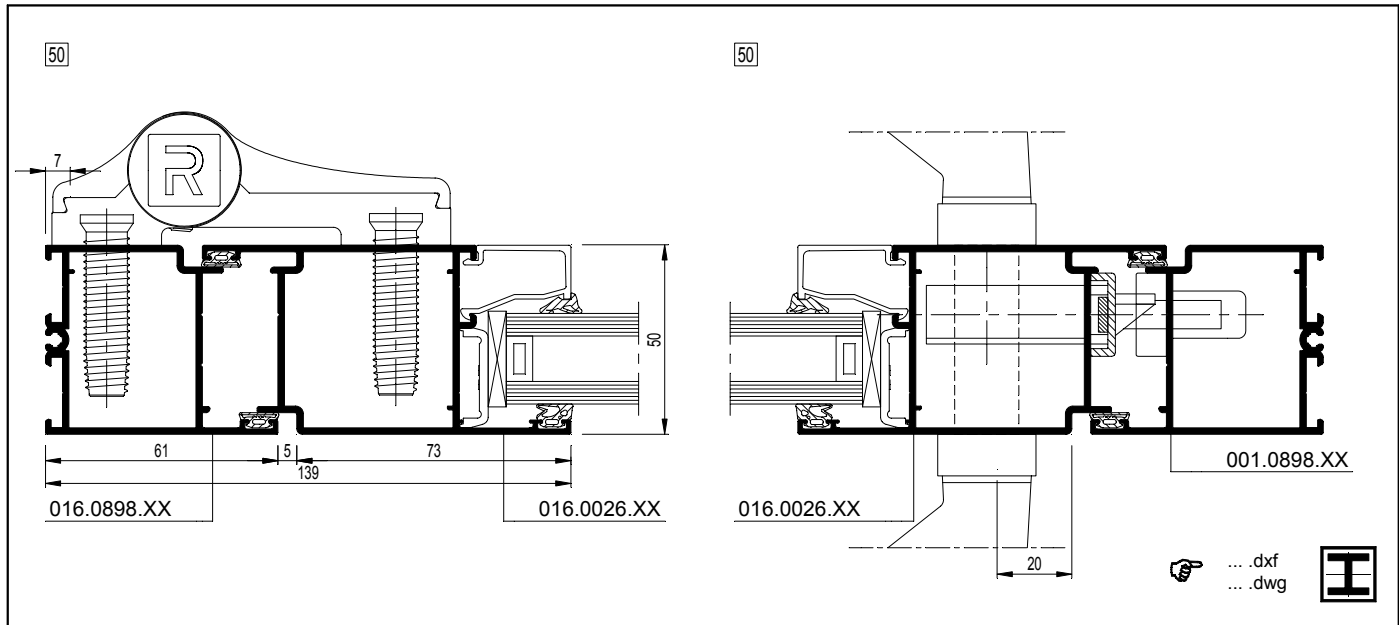
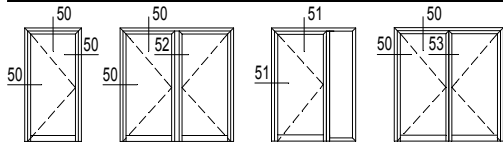

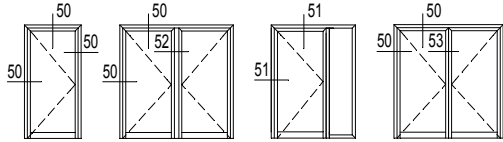

016.0898.XX

$I_x = 13.668 \text{ cm}^4$

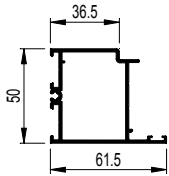

50 CS59Pa-050001.dxf
 CS59Pa-050001.dwg

016.0014.XX

$I_x = 17.961 \text{ cm}^4$

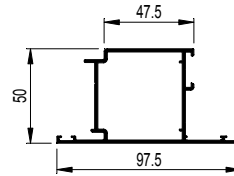

50 CS59Pa-050002.dxf
 CS59Pa-050002.dwg

53 ZT

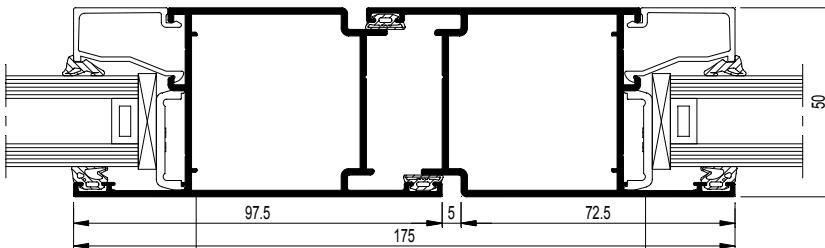

016.0014.XX

016.0026.XX

CS59Pa-053001.dxf
 CS59Pa-053001.dwg

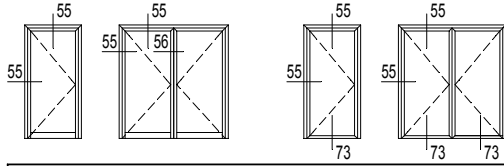

55

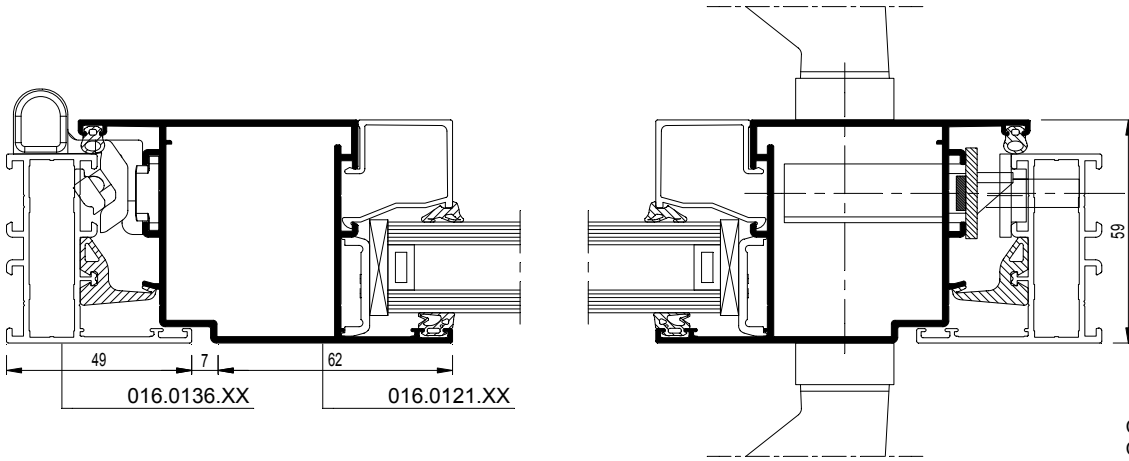

CS59Pa-055001.dxf
 CS59Pa-055001.dwg

56

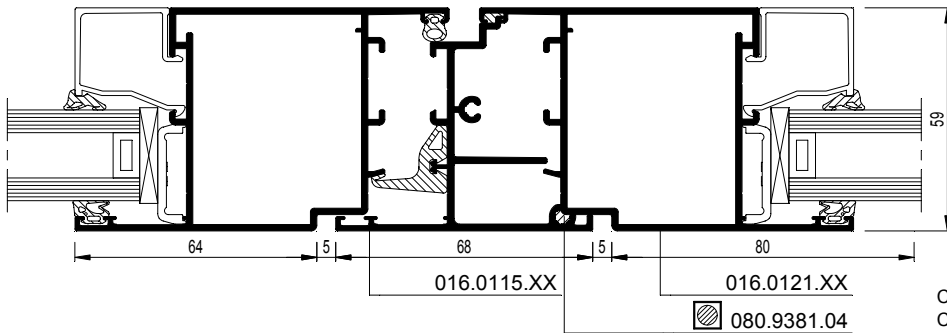

CS59Pa-056001.dxf
 CS59Pa-056001.dwg

73

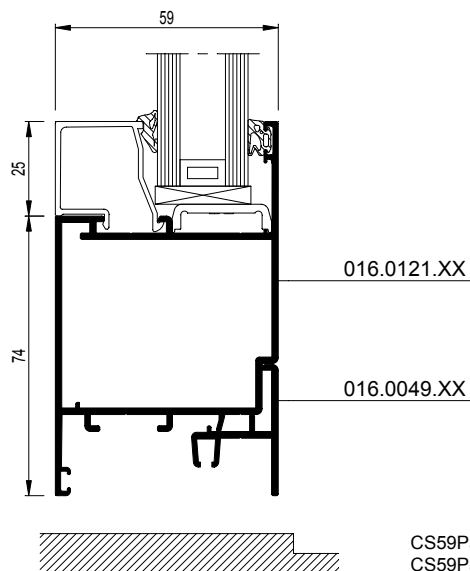

CS59Pa-073001.dxf
 CS59Pa-073001.dwg

CS 59Pa

Deuren - Naar binnen draaiende deuren met deurvleugel rondom geperst
 Portes - Portes ouvrant vers l'intérieur avec ouvrant serti tout autour
 Doors - Inward opening doors with vent crimped all round
 Türen - Nach innen öffnende Türen mit rundherum gepresstem Türflügel

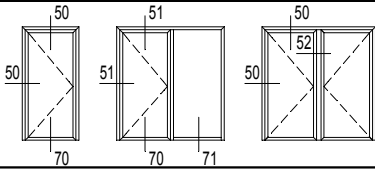

70

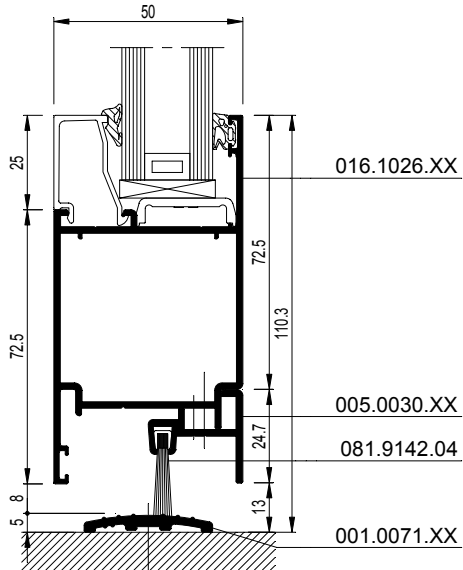

CS59Pa-070001.dxf
 CS59Pa-070001.dwg

71

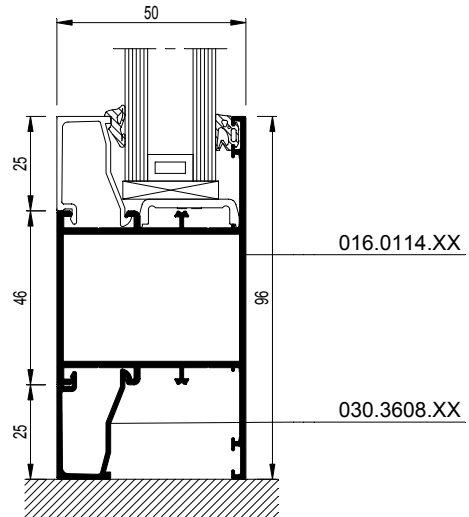

CS59Pa-071001.dxf
 CS59Pa-071001.dwg

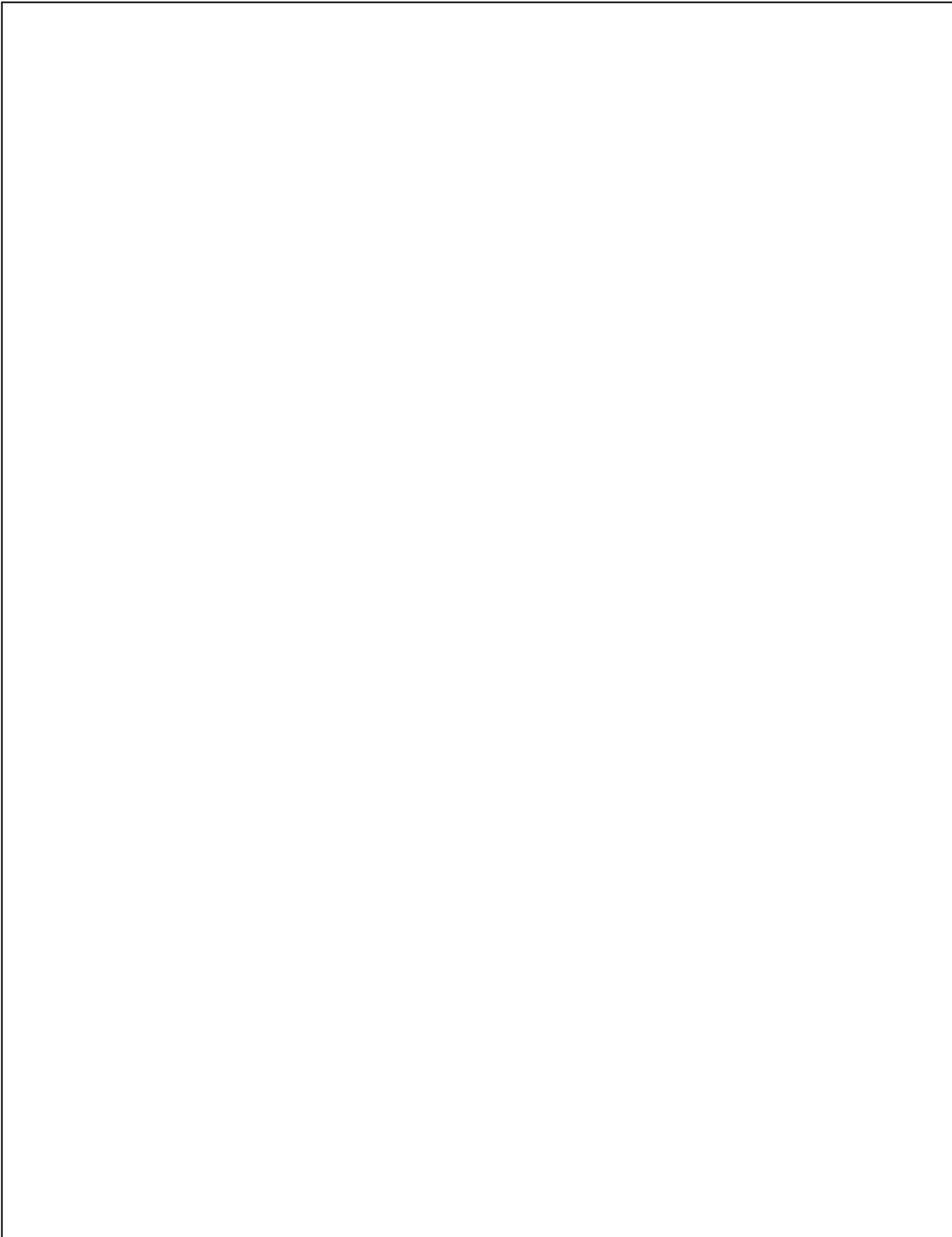

CS 59Pa

Deuren naar binnen draaiend - Deuren met T-profiel
Portes ouvrant vers l'intérieur - Portes avec traverse
Doors inward opening - Doors with transom-mullion
Türen nach innen öffnend - Türen mit T-profilsockel

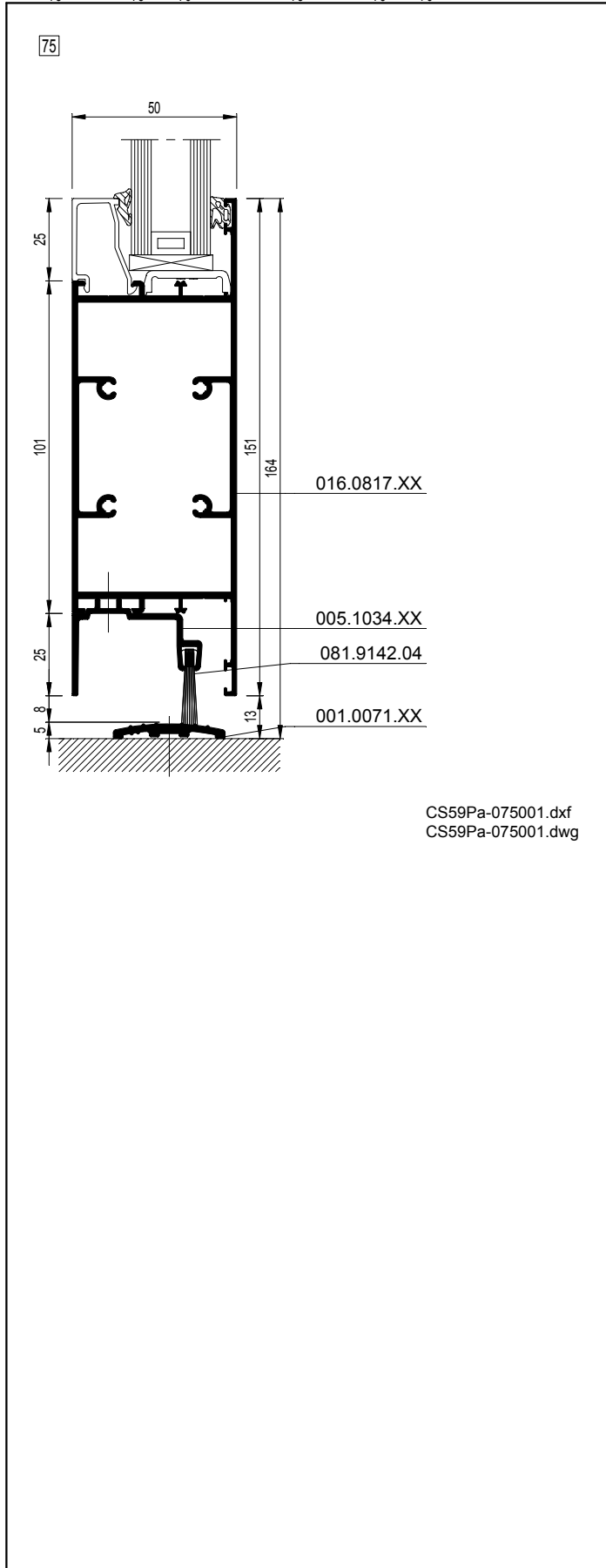
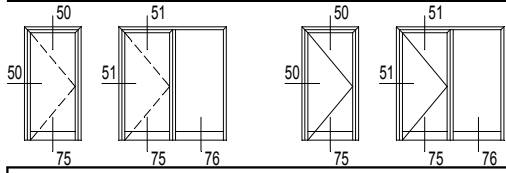

CS59Pa-075001.dxf
CS59Pa-075001.dwg

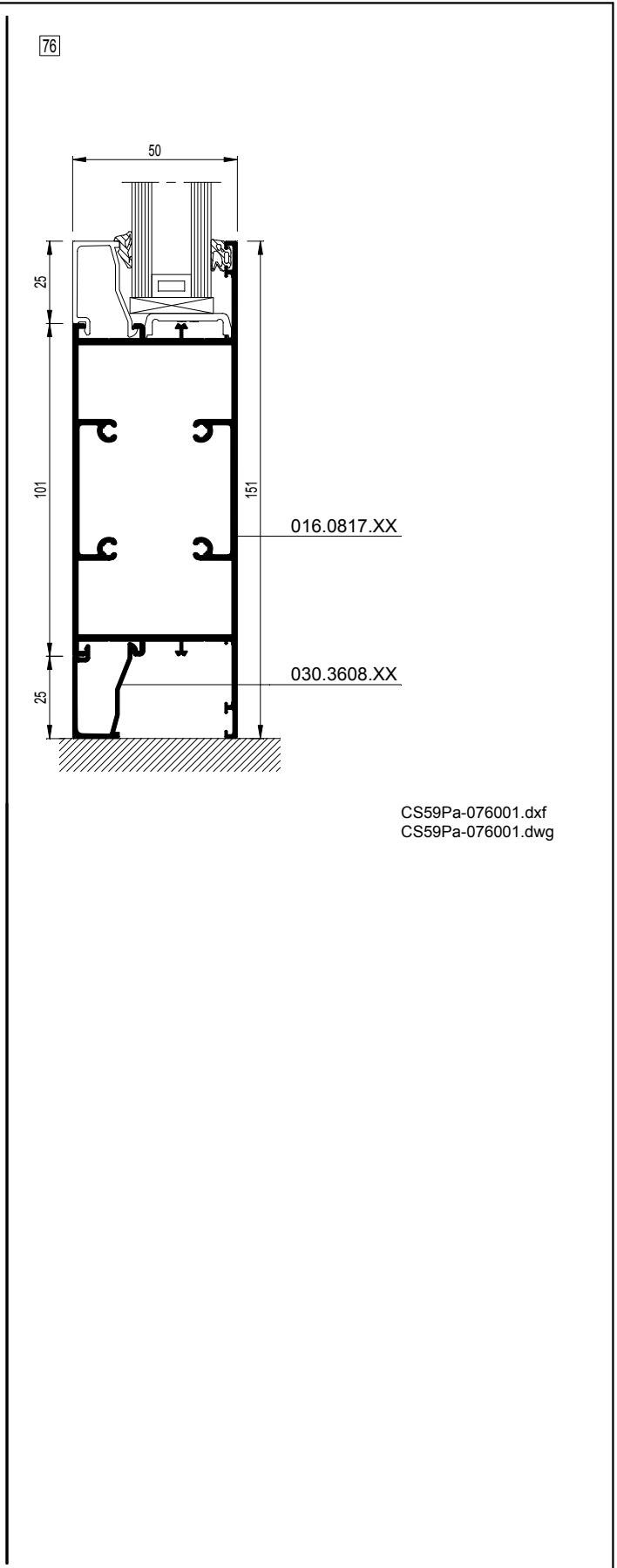

CS59Pa-076001.dxf
CS59Pa-076001.dwg

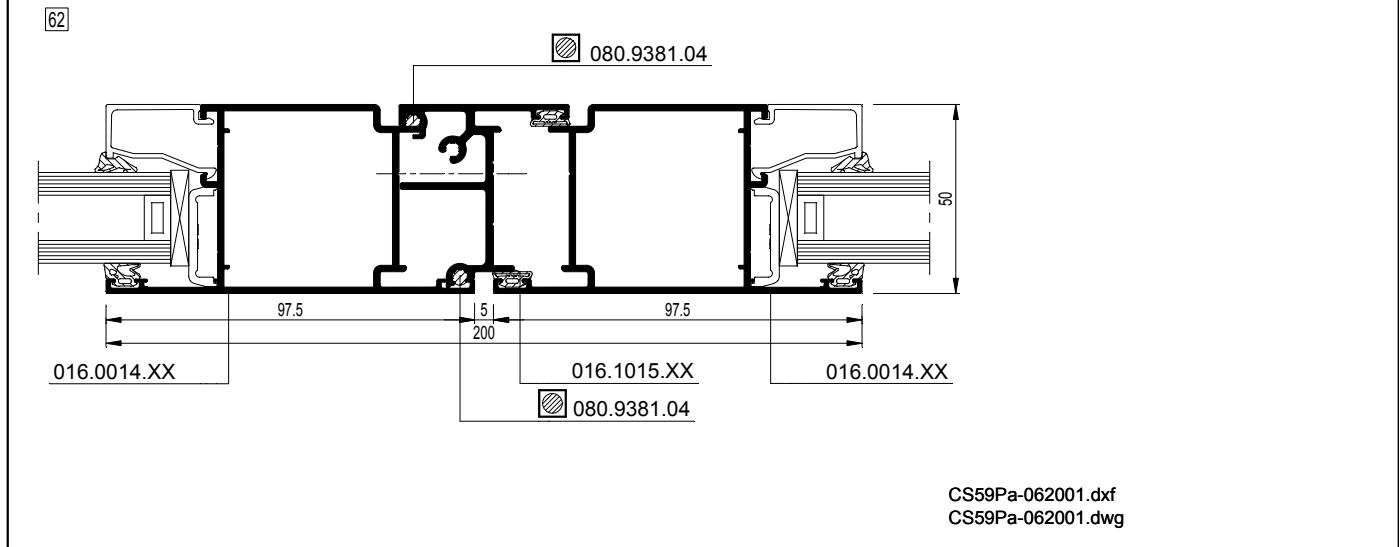
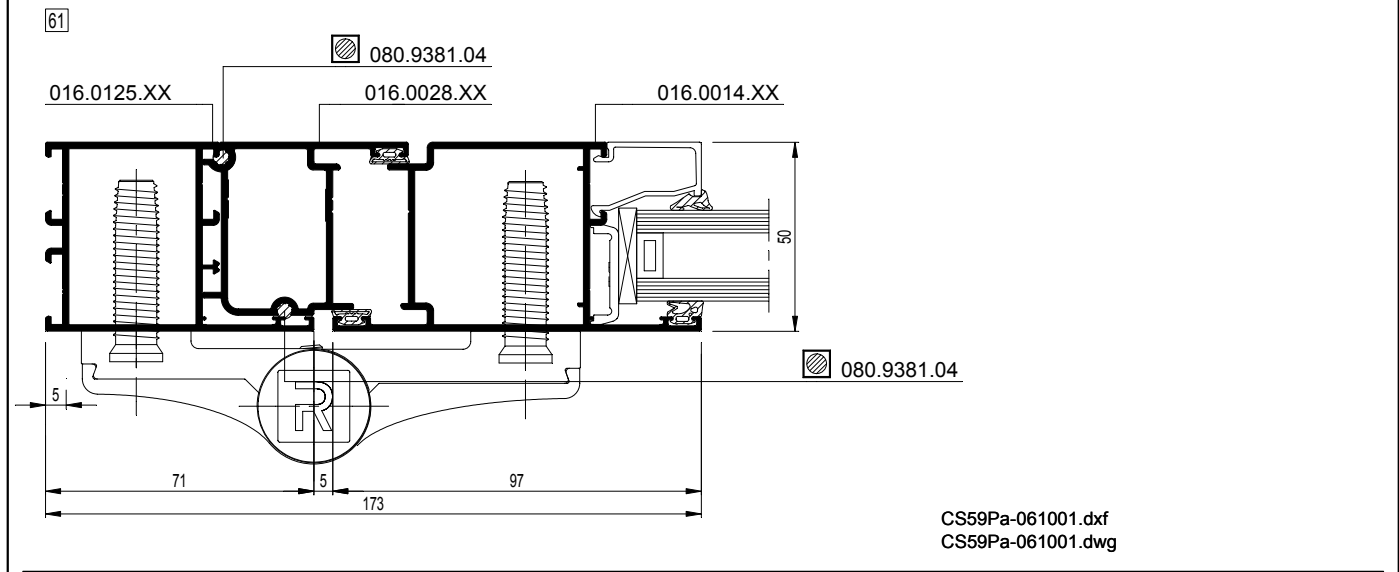
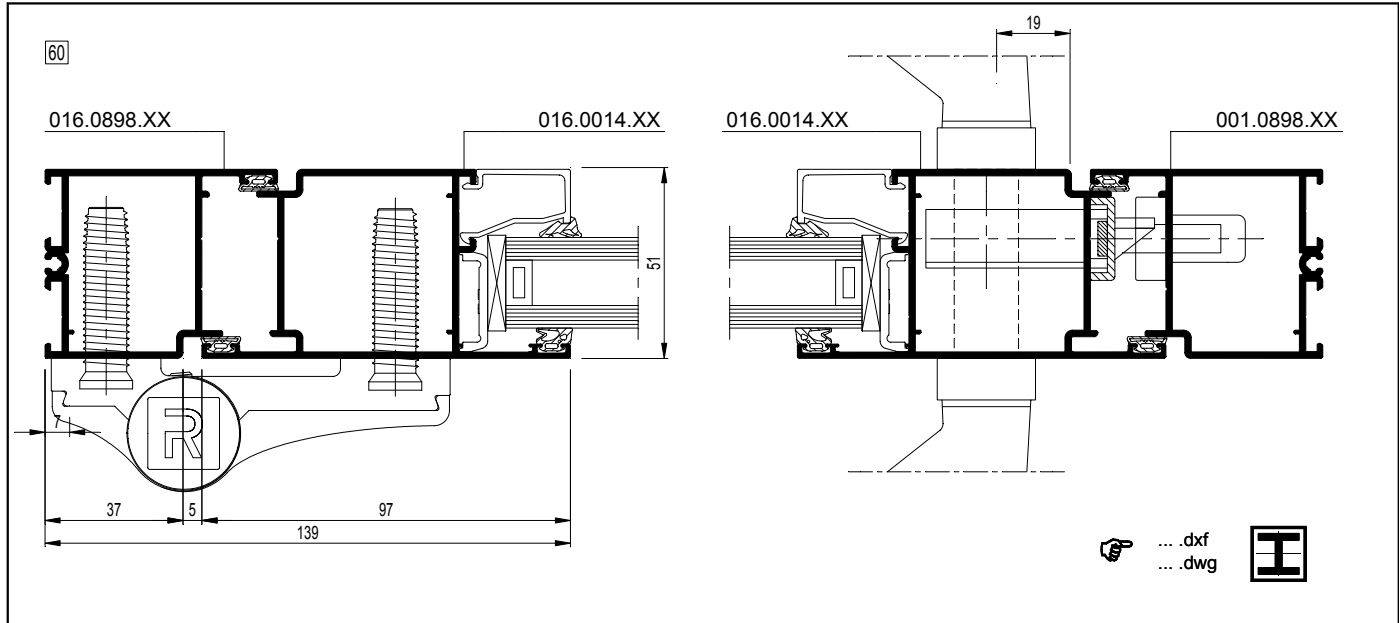
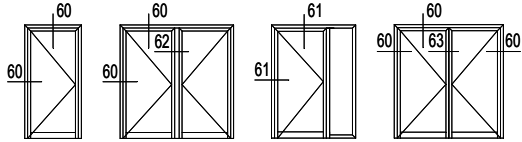

CS 59Pa

Deuren naar buiten draaiend - Naar buiten opengaande deuren
 Portes ouvrant vers l'extérieur - Portes ouvrant vers l'extérieur
 Doors outward opening - Outward opening doors
 Türen nach außen öffnend - Nach außen öffnende Türen

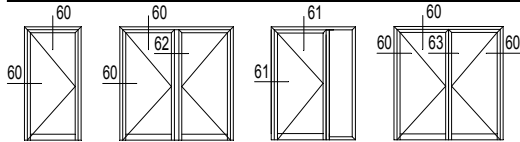

016.0898.XX

$I_x = 13.668 \text{ cm}^4$

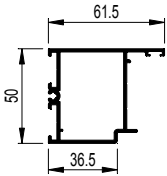

CS-59Pa-060001.dxf
 CS-59Pa-060001.dwg

016.0026.XX

$I_x = 18.889 \text{ cm}^4$

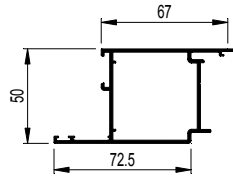

CS-59Pa-060002.dxf
 CS-59Pa-060002.dwg

ZT

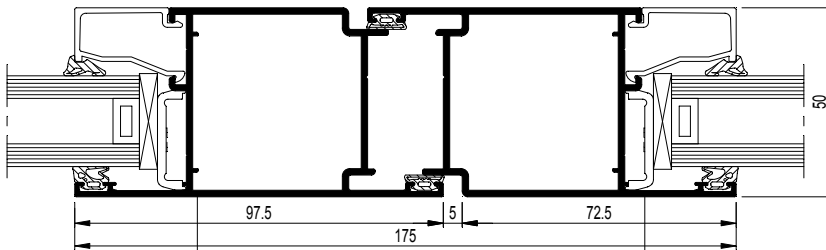

016.0014.XX

016.0026.XX

CS-59Pa-063001.dxf
 CS-59Pa-063001.dwg

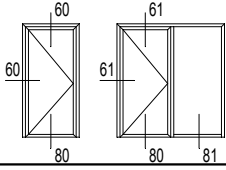

80

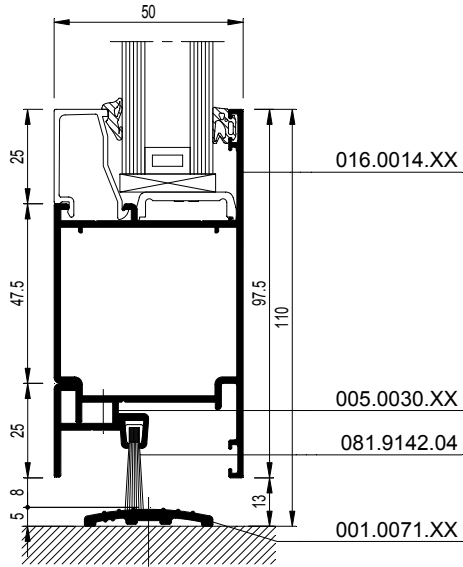

CS59Pa-080001.dxf
 CS59Pa-080001.dwg

81

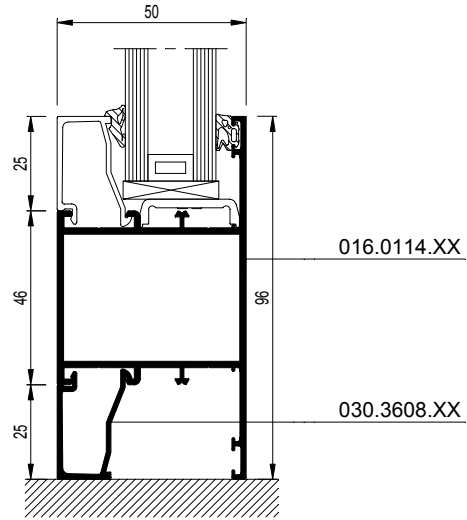

CS59Pa-081001.dxf
 CS59Pa-081001.dwg

CS 59Pa



CS 59Pa Front (CS 59Pa-Fr)

Schiebe-kiptür

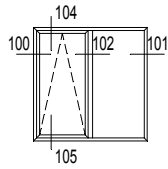

CS 59Pa-Fr - 102

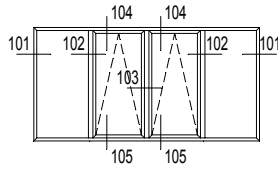

CS 59Pa-Fr - 103

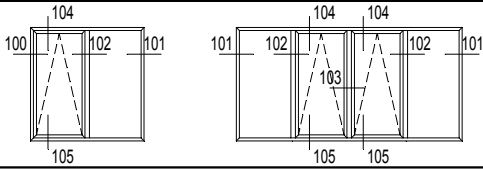

100 11

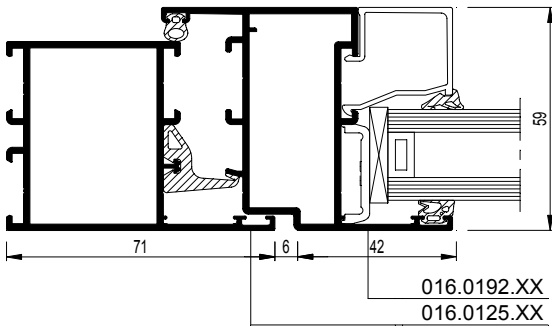

CS59Pa-100001.dxf
 CS59Pa-100001.dwg

101 1

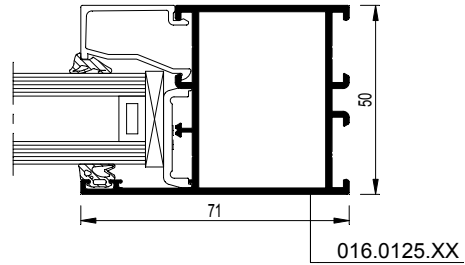

CS59Pa-101001.dxf
 CS59Pa-101001.dwg

102 21

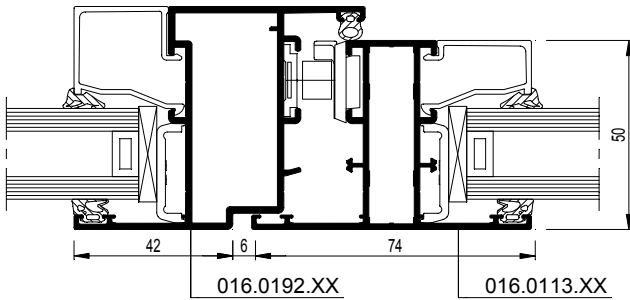

CS59Pa-102001.dxf
 CS59Pa-102001.dwg

103 12

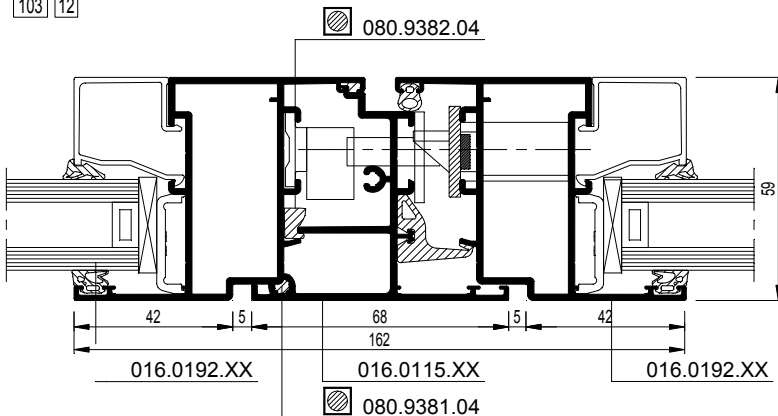

CS59Pa-103001.dxf
 CS59Pa-103001.dwg

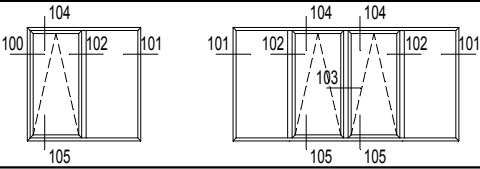

104

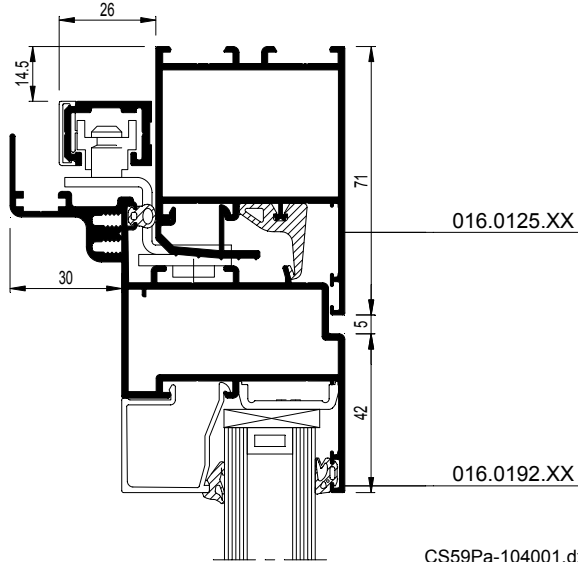

CS59Pa-104001.dxf
 CS59Pa-104001.dwg

105

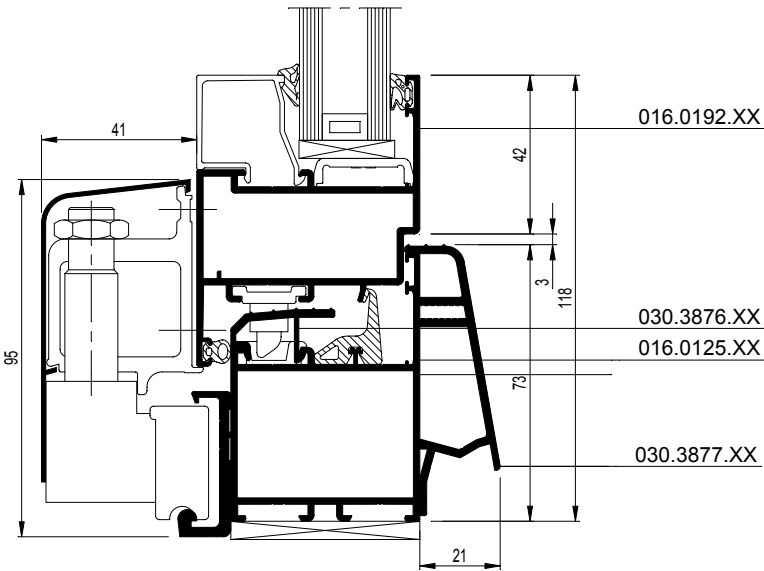

CS59Pa-105001.dxf
 CS59Pa-105001.dwg

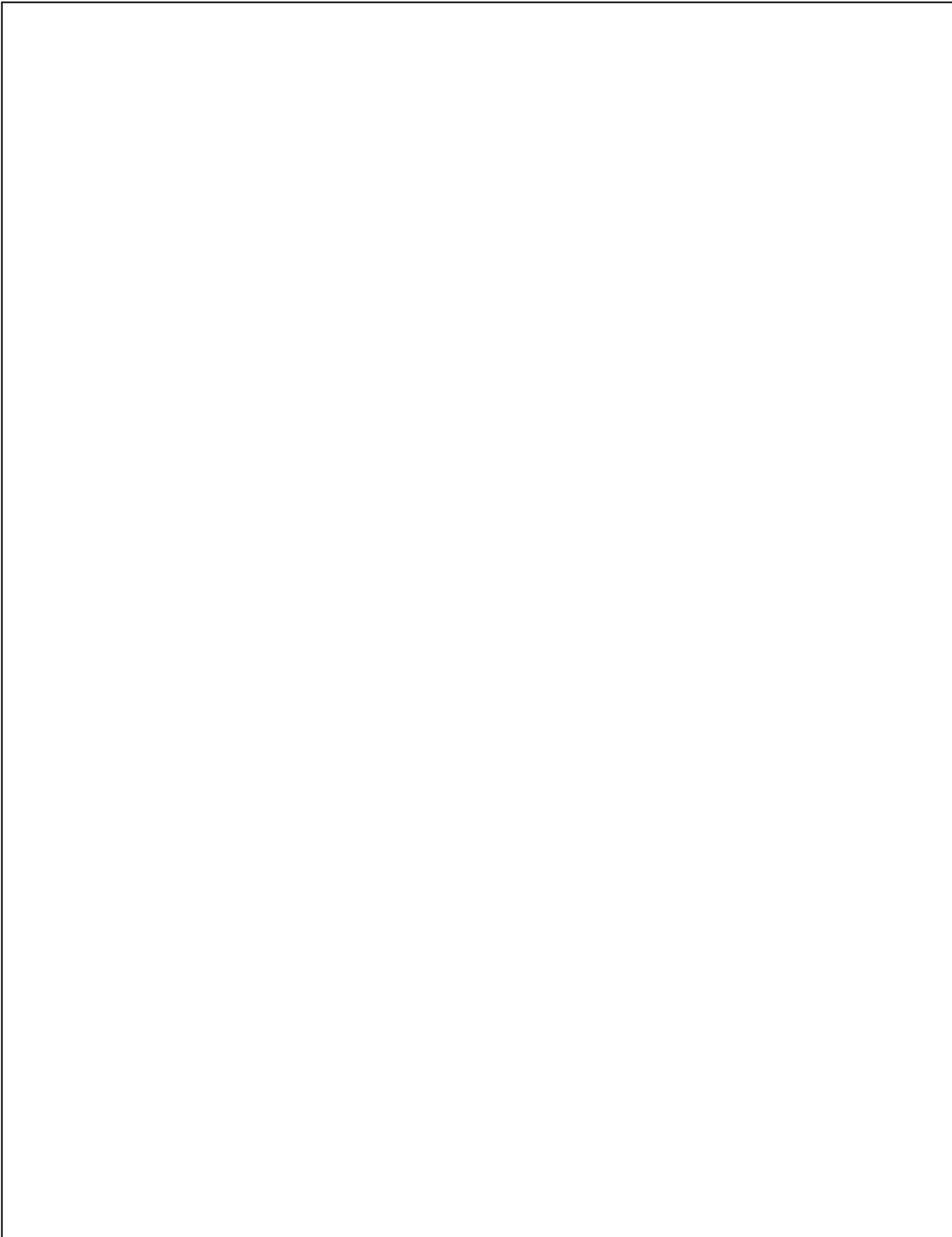



CS 59Pa Automatic Sliding Door (CS 59Pa-AD)

Schiebetüren

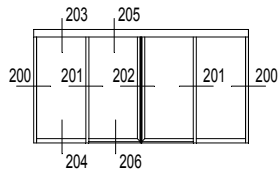

- CS 59Pa - 202
- CS 59Pa - 203
- CS 59Pa - 204

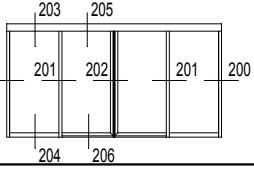

200

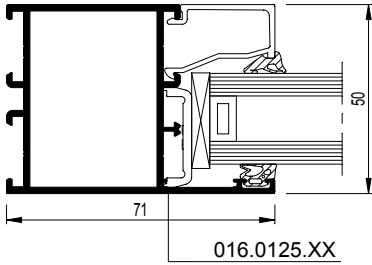

016.0125.XX

CS59Pa-200001.dxf
 CS59Pa-200001.dwg

201

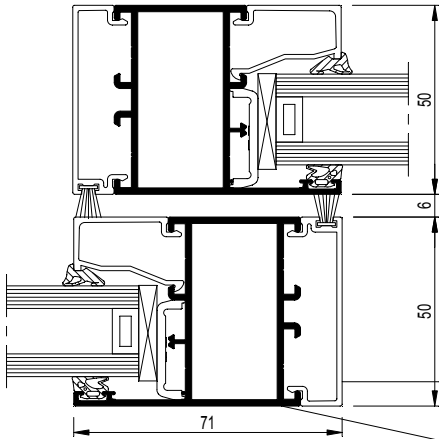

016.0590.XX

016.0183.XX

CS59Pa-201001.dxf
 CS59Pa-201001.dwg

202

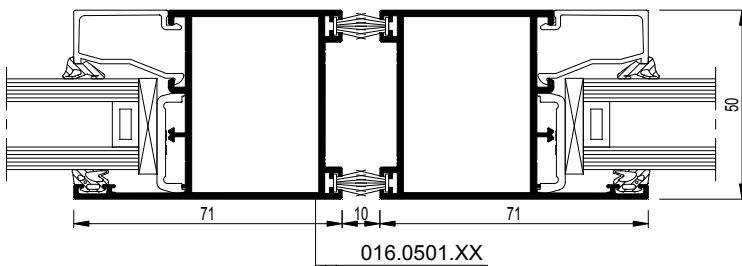

016.0501.XX

CS59Pa-202001.dxf
 CS59Pa-202001.dwg

CS 59Pa-AD

Automatische schuifdeuren
Portes coulissantes automatiques
Automatic sliding door
Automatische Schiebetüren

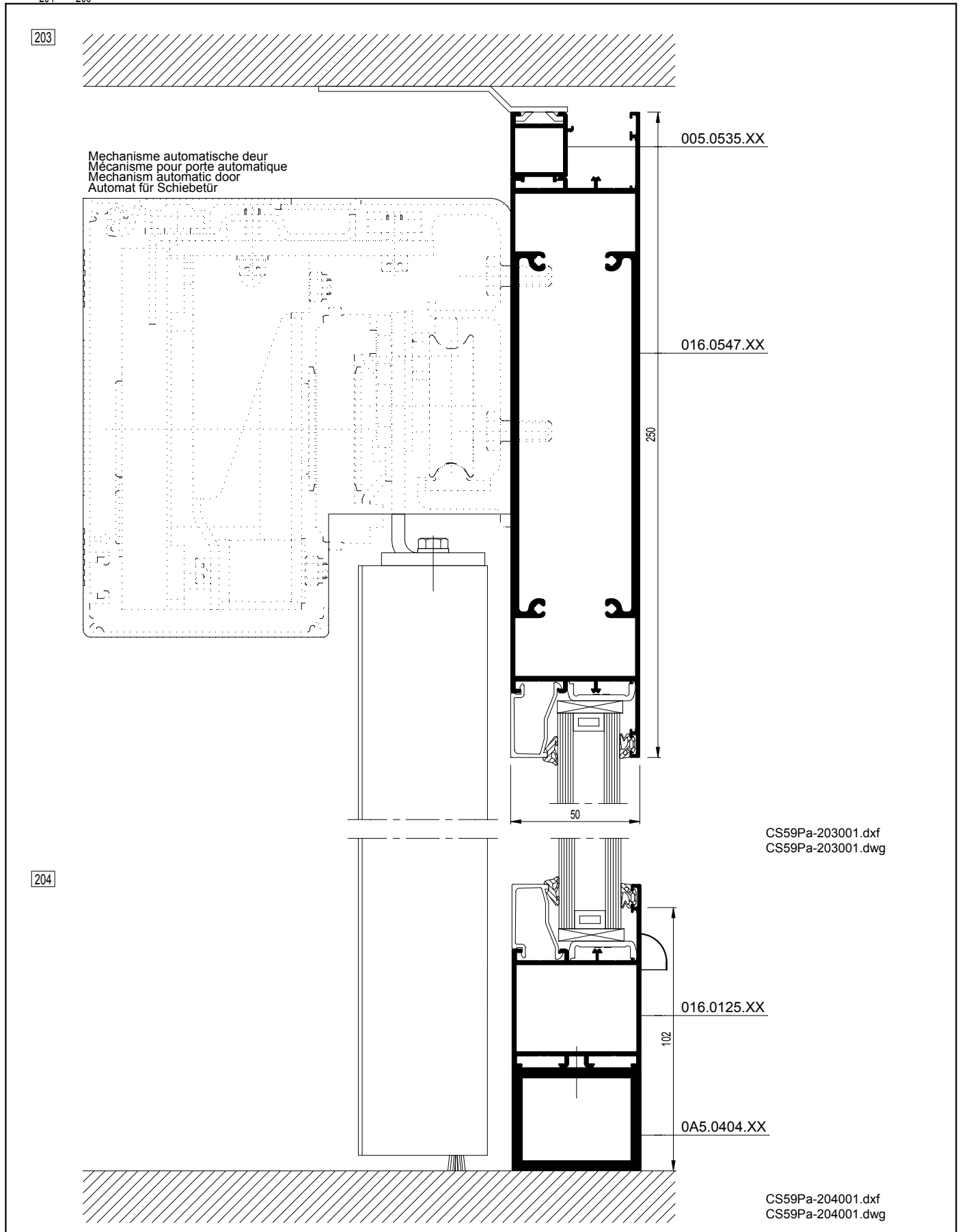
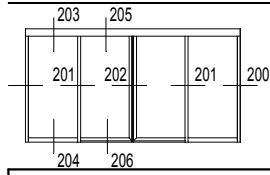

CS 59Pa-AD

Automatische schuifdeuren
Portes coulissantes automatiques
Automatic sliding door
Automatische Schiebetüren

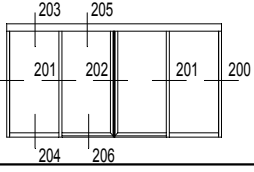

205

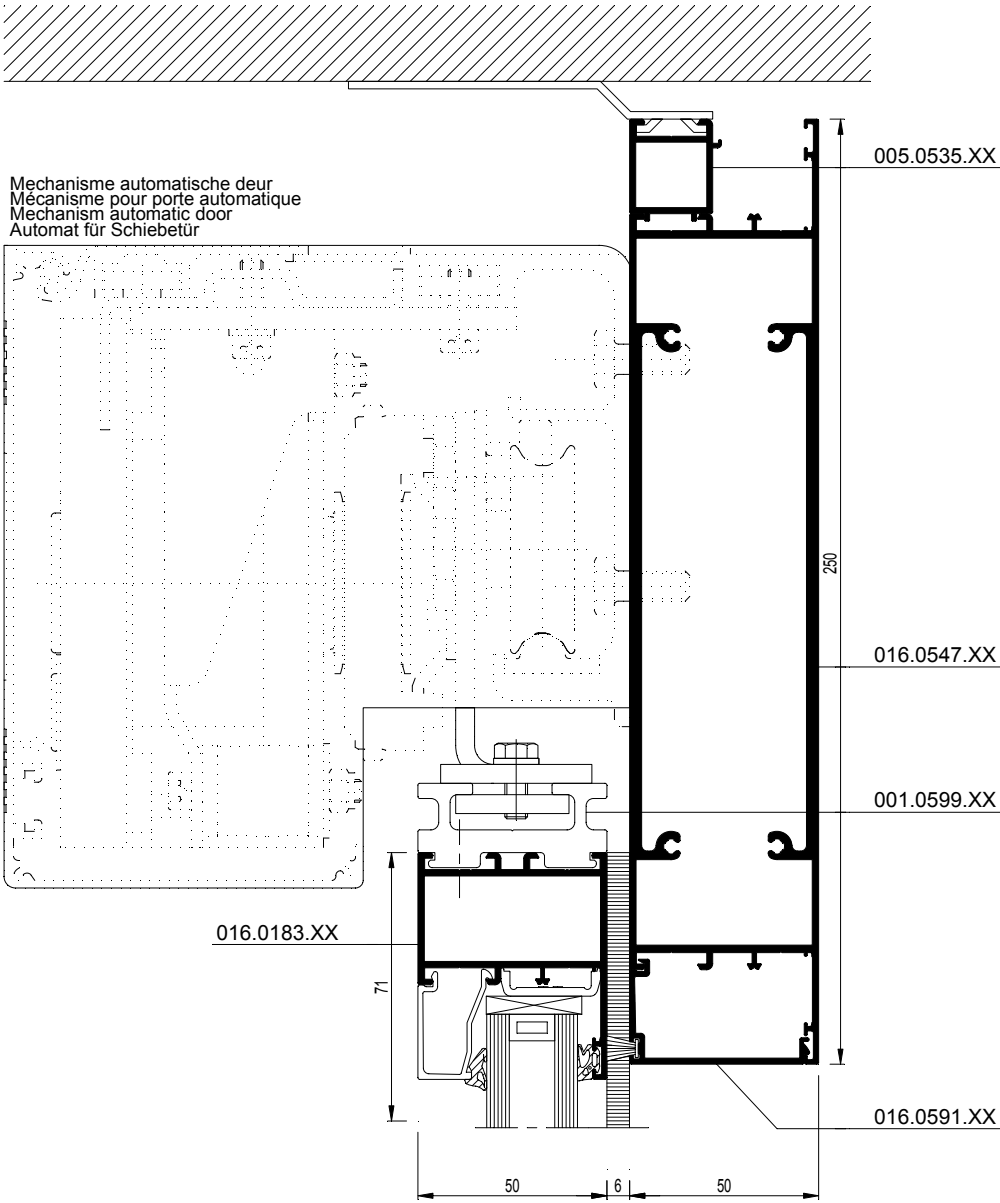

CS59Pa-205001.dxf
CS59Pa-205001.dwg

206

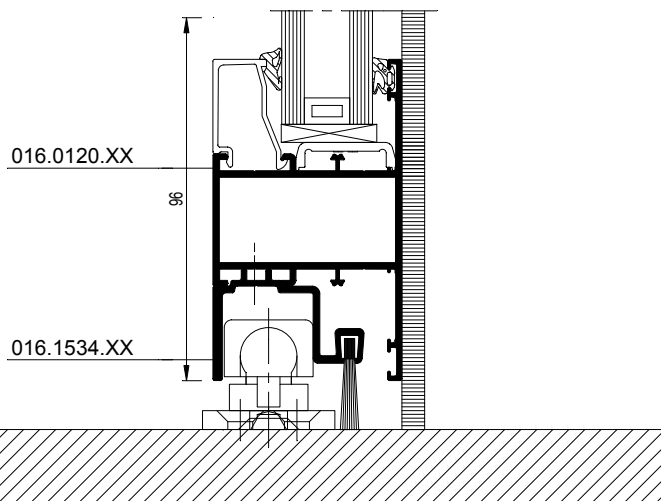

CS59Pa-206001.dxf
CS59Pa-206001.dwg



CS 59Pa Swing Door (CS 59Pa-SD)

1 Einzelne Tür mit Fingerschutz

Rohrtuerschliesser Tür mit Fingerschutz

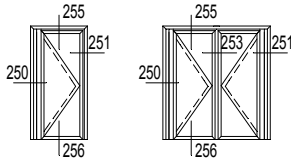

CS 59Pa - 250
CS 59Pa - 251

Bodentuerschliesser Tür mit Fingerschutz

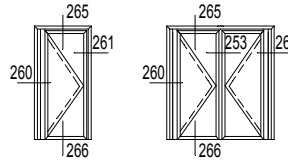

CS 59Pa - 256
CS 59Pa - 257

2 Einzelne Tür mit Fingerschutz

Rohrtuerschliesser Tür ohne Fingerschutz

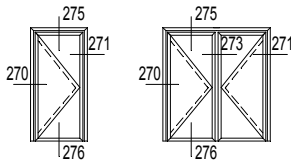

CS 59Pa - 260
CS 59Pa - 261

Bodentuerschliesser Tür ohne Fingerschutz

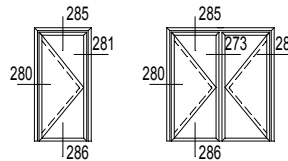

CS 59Pa - 266
CS 59Pa - 267

CS 59Pa-SD

Deur met vingerbeveiliging - Kozijndorpelveer deur met vingerbeveiliging
 Porte avec anti-pince-doigts - Pivot de frein aerien porte avec anti-pince-doigts
 Door with finger protection - Overhead closer door with finger protection
 Einzelne Tür mit Fingerschutz - Rohrtuerschliesser Tür mit Fingerschutz

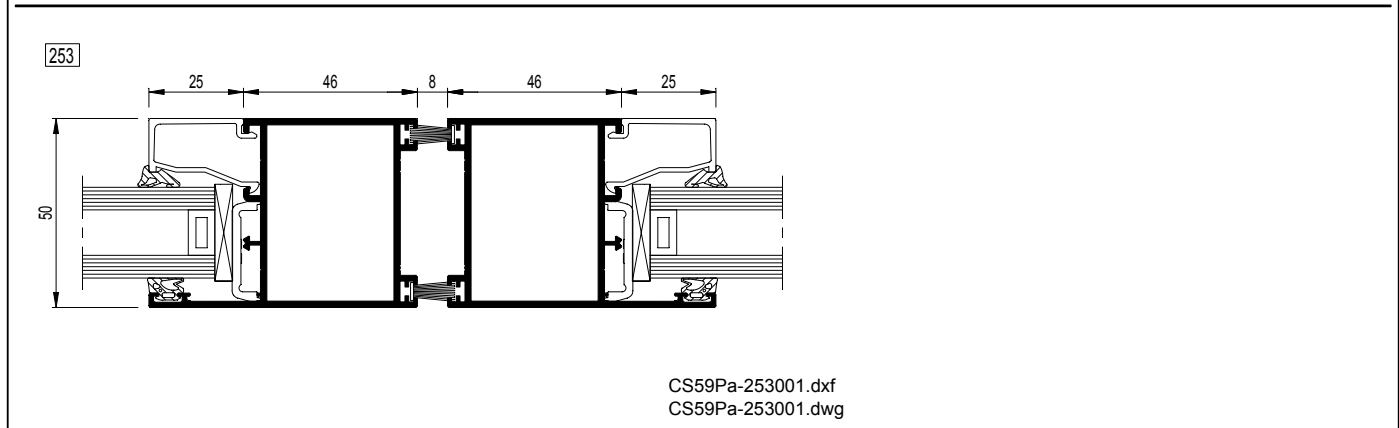
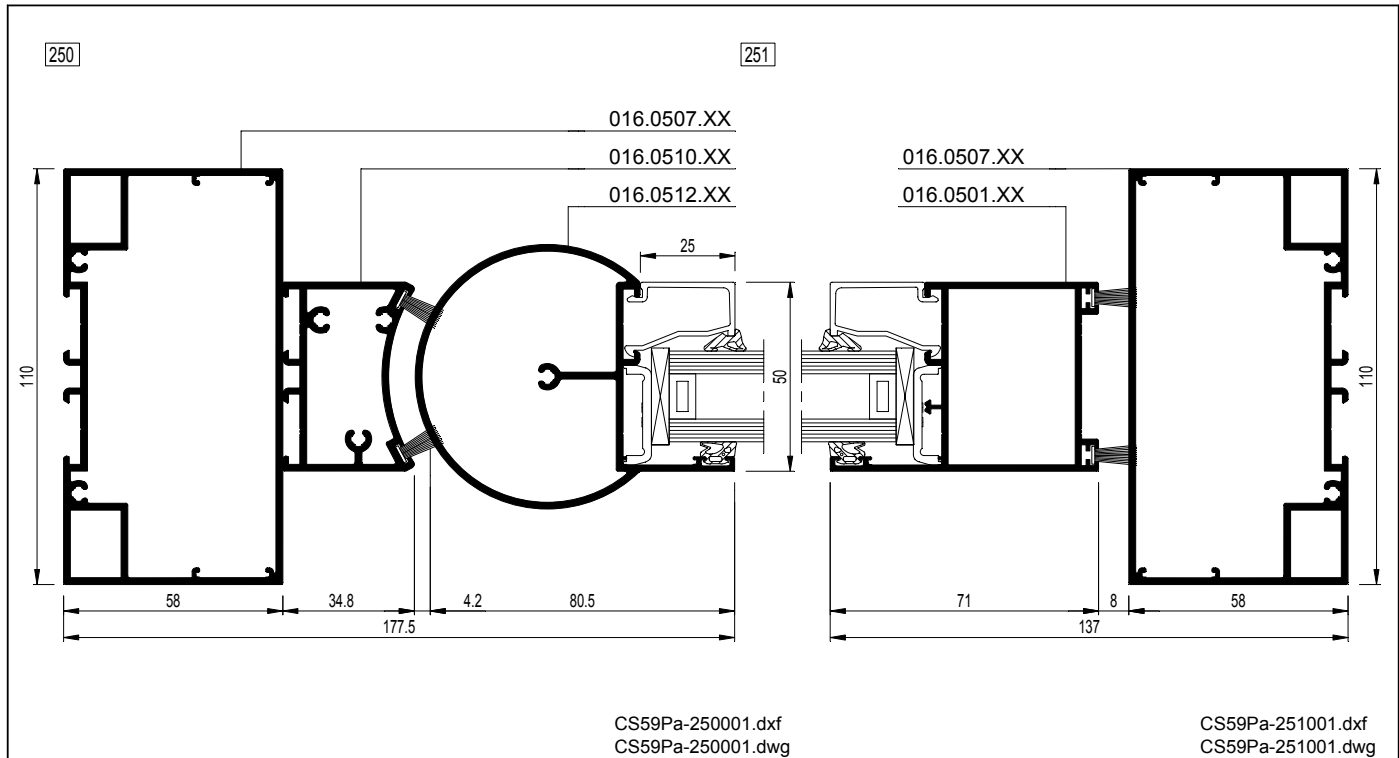
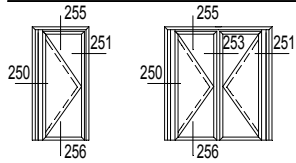

CS 59Pa-SD

Deur met vingerbeveiliging - Kozijndorpelveer deur met vingerbeveiliging
Porte avec anti-pince-doigts - Pivot de frein aerien porte avec anti-pince-doigts
Door with finger protection - Overhead closer door with finger protection
Einzelne Tür mit Fingerschutz - Rohrtuerschliesser Tür mit Fingerschutz

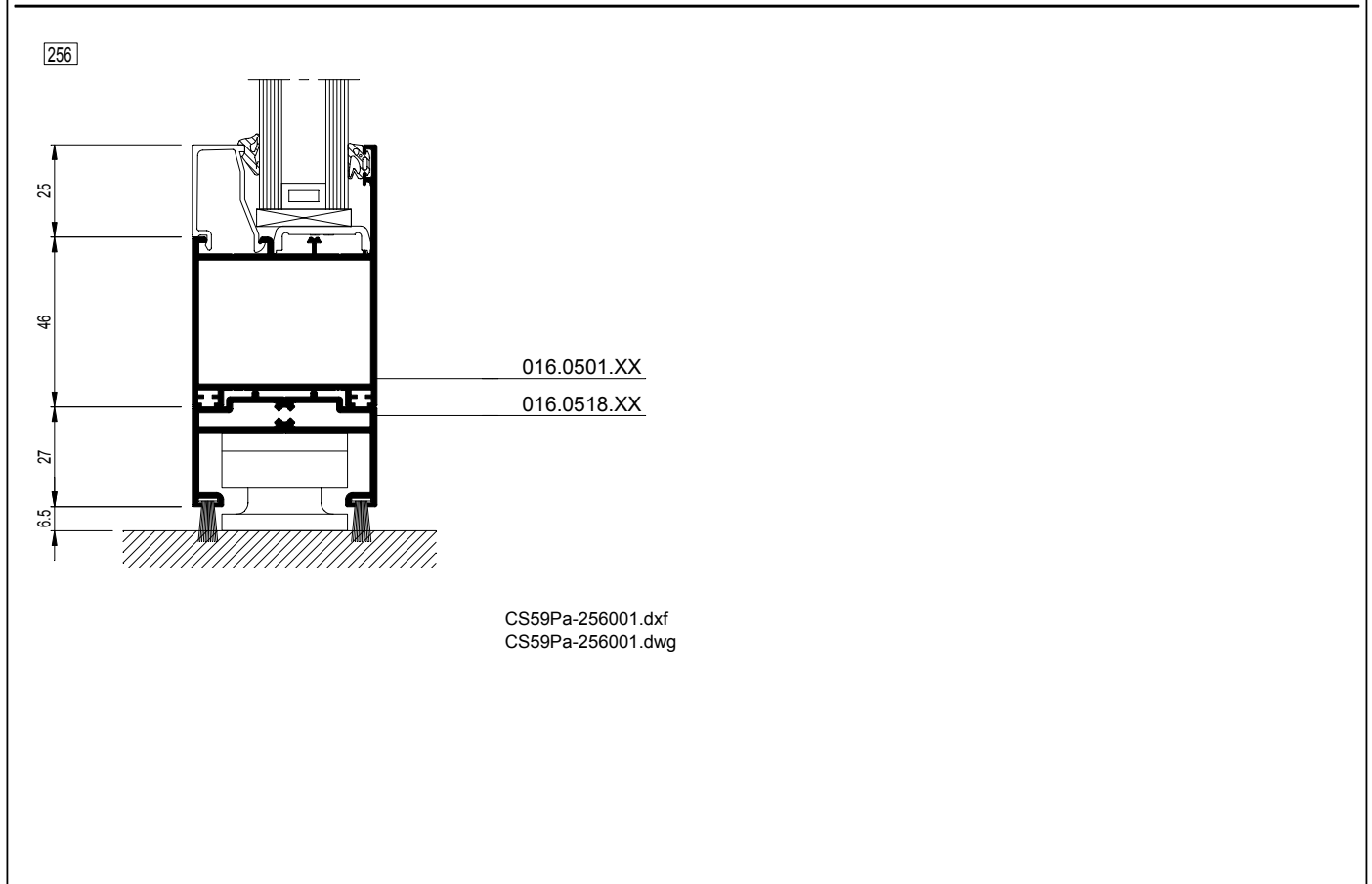
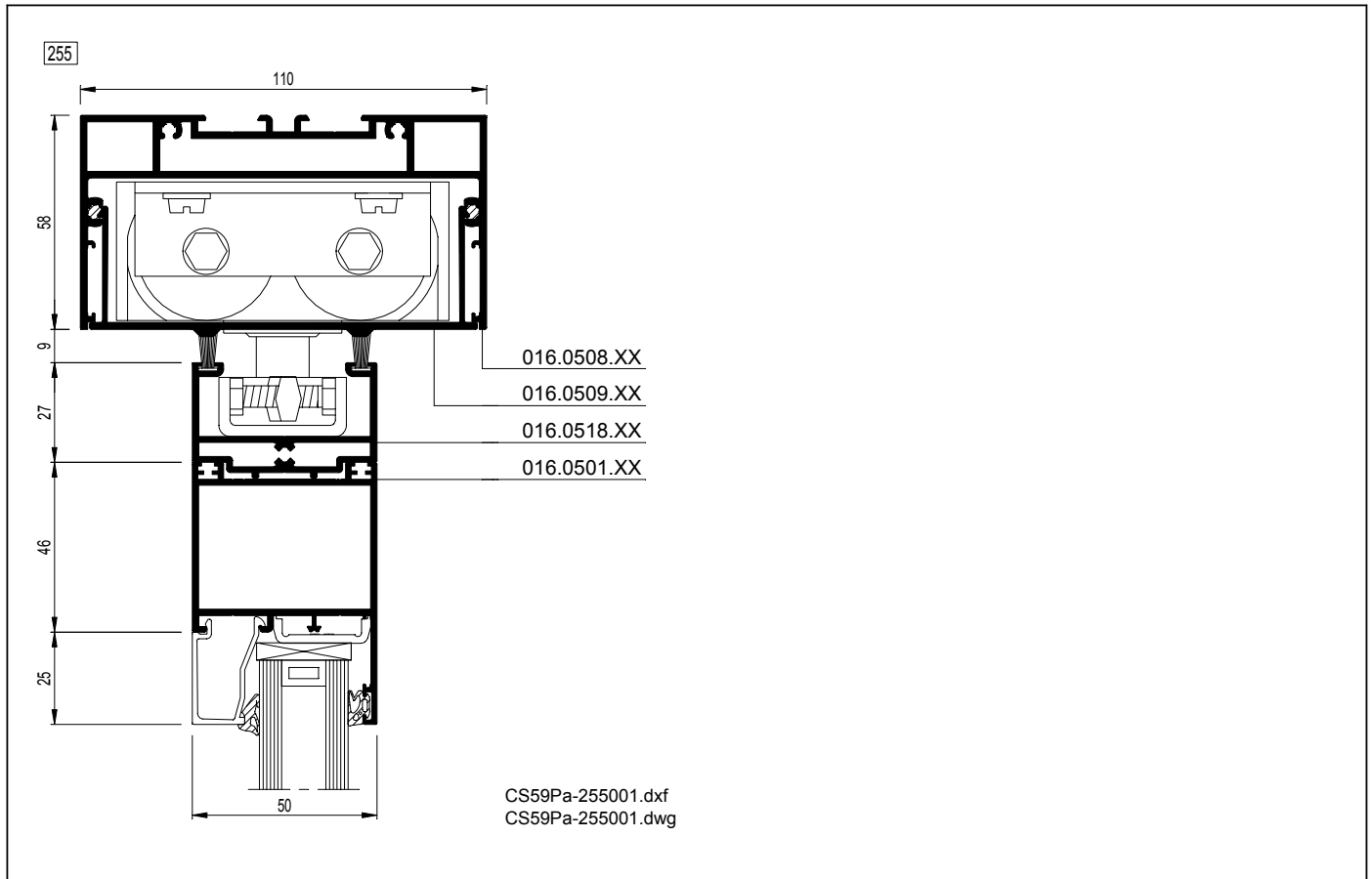
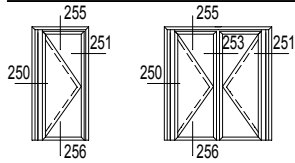

CS 59Pa-SD

Deur met vingerbeveiliging - Vloerveer deur met vingerbeveiliging
Porte avec anti-pince-doigts - Pivot de frein au sol porte avec anti-pince-doigts
Door with finger protection - Floor closer door with finger protection
Einzelne Tür mit Fingerschutz - Bodentuerschliesser Tür mit Fingerschutz

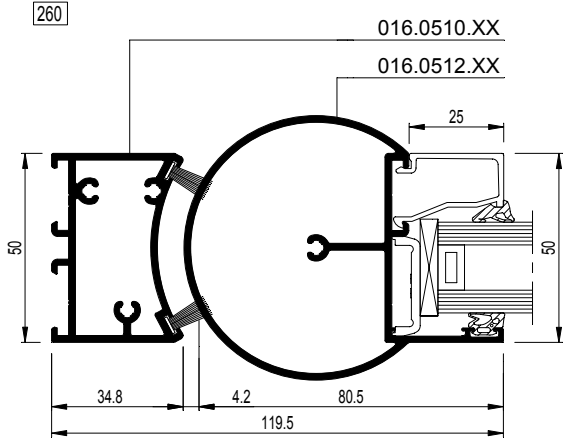
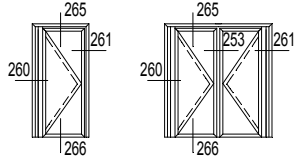

CS59Pa-260001.dxf
CS59Pa-260001.dwg

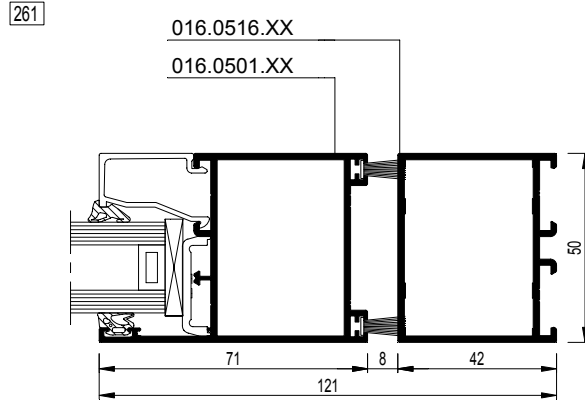

CS59Pa-261001.dxf
CS59Pa-261001.dwg

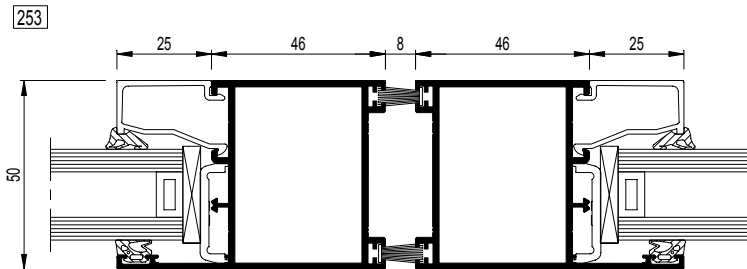

CS59Pa-253001.dxf
CS59Pa-253001.dwg

CS 59Pa-SD

Deur met vingerbeveiliging - Kozjindorpelveer deur met vingerbeveiliging
Porte avec anti-pince-doigts - Pivots de frein aerien porte avec anti-pince-doigts
Door with finger protection - Overhead closer door with finger protection
Einzelne Tür mit Fingerschutz - Rohrtuerschliesser Tür mit Fingerschutz

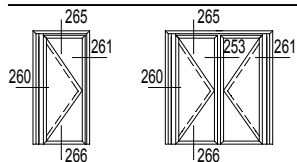

265

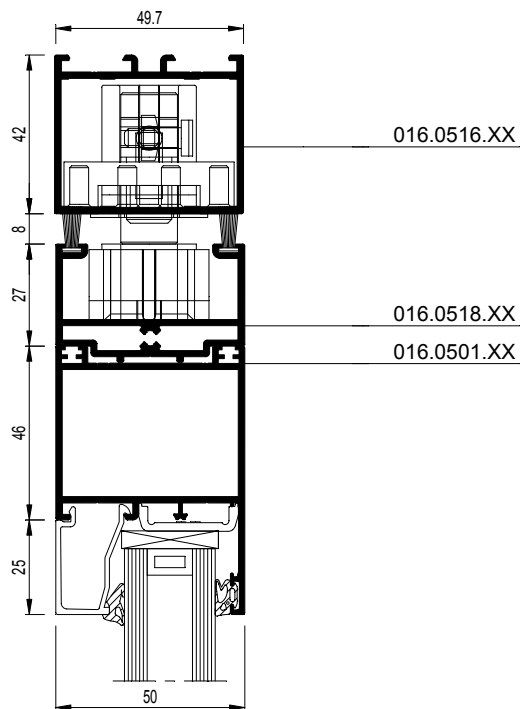

CS59Pa-265001.dxf
CS59Pa-265001.dwg

266

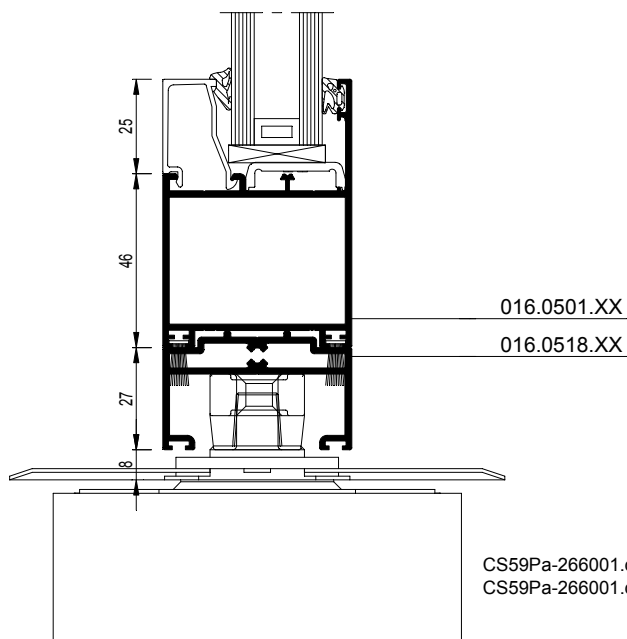

CS59Pa-266001.dxf
CS59Pa-266001.dwg

CS 59Pa-SD

Deur zonder vingerbeveiliging - Kozijdorpelveer deur zonder vingerbeveiliging
 Porte sans anti-pince-doigts - Pivot de frein aerien porte sans anti-pince-doigts
 Door without finger protection - Overhead closer door without finger protection
 Einzelne Tür ohne Fingerschutz - Rohrtuerschliesser Tür ohne Fingerschutz

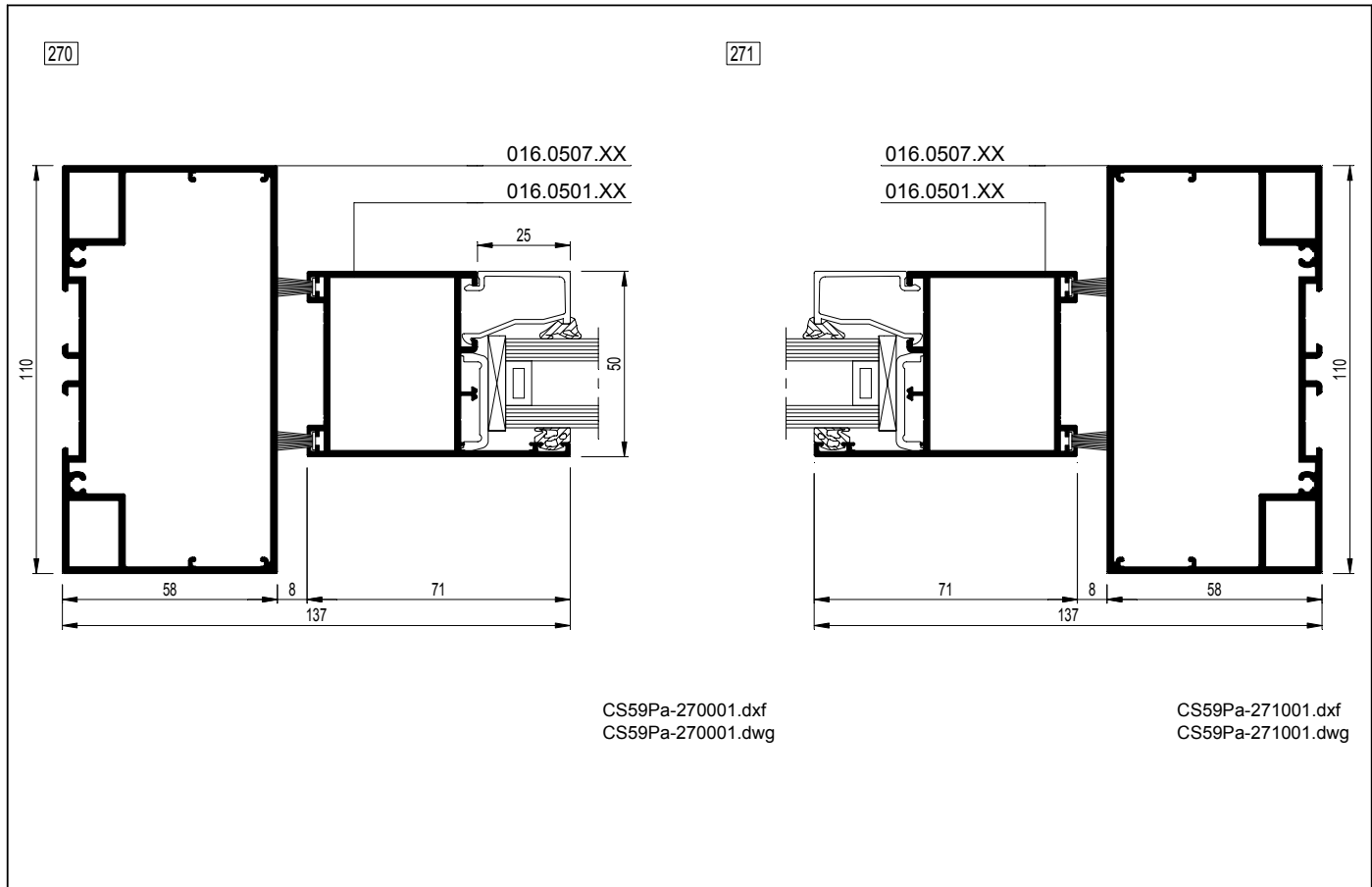
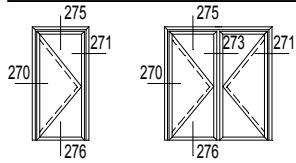

CS59Pa-270001.dxf
 CS59Pa-270001.dwg

CS59Pa-271001.dxf
 CS59Pa-271001.dwg

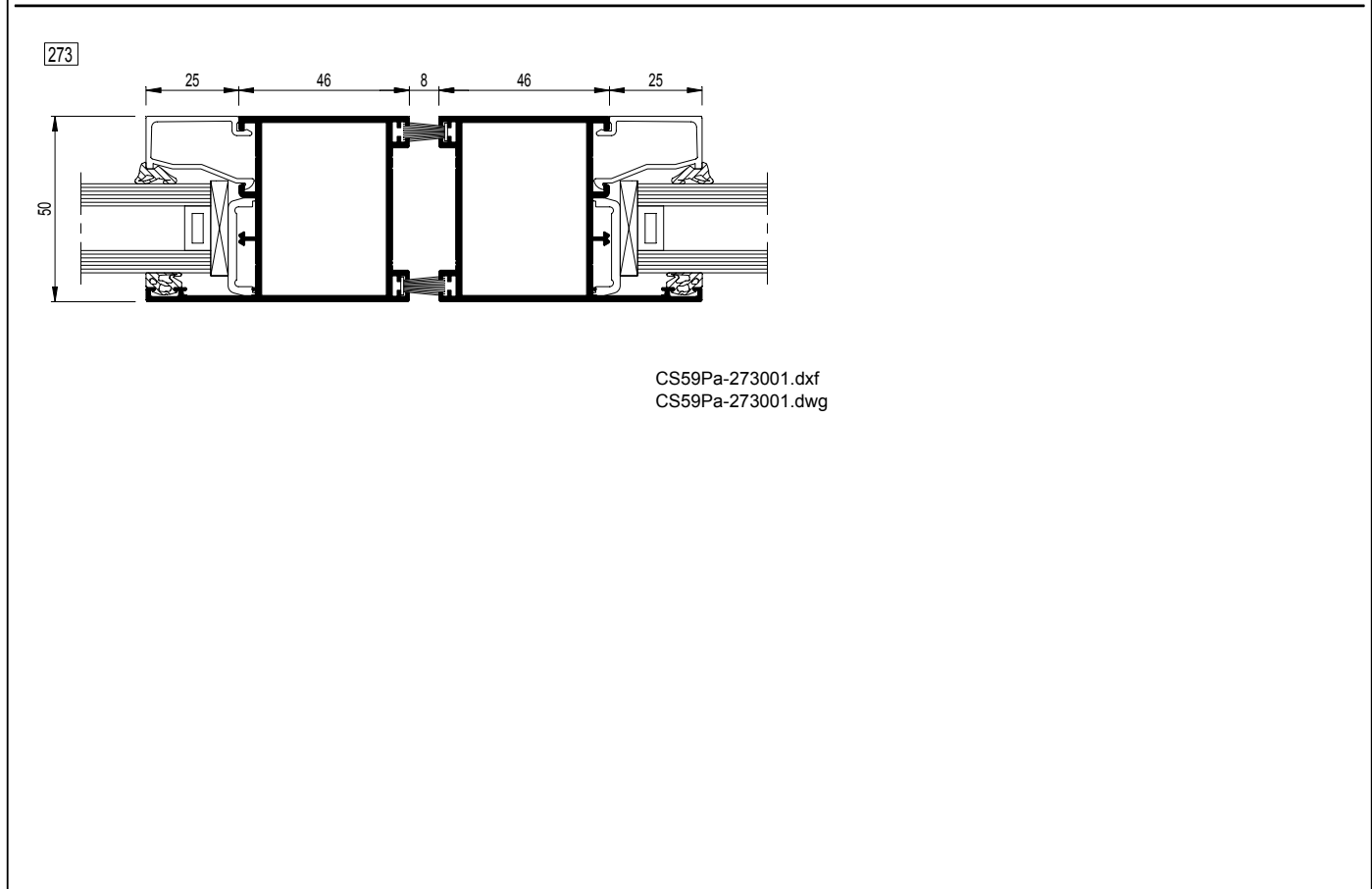

CS59Pa-273001.dxf
 CS59Pa-273001.dwg

CS 59Pa-SD

Deur zonder vingerbeveiliging - Kozijndorpelveer deur zonder vingerbeveiliging
 Porte sans anti-pince-doigts - Pivots de frein aerien porte sans anti-pince-doigts
 Door without finger protection - Overhead closer door without finger protection
 Einzelne Tür ohne Fingerschutz - Rohrtuerschliesser Tür ohne Fingerschutz

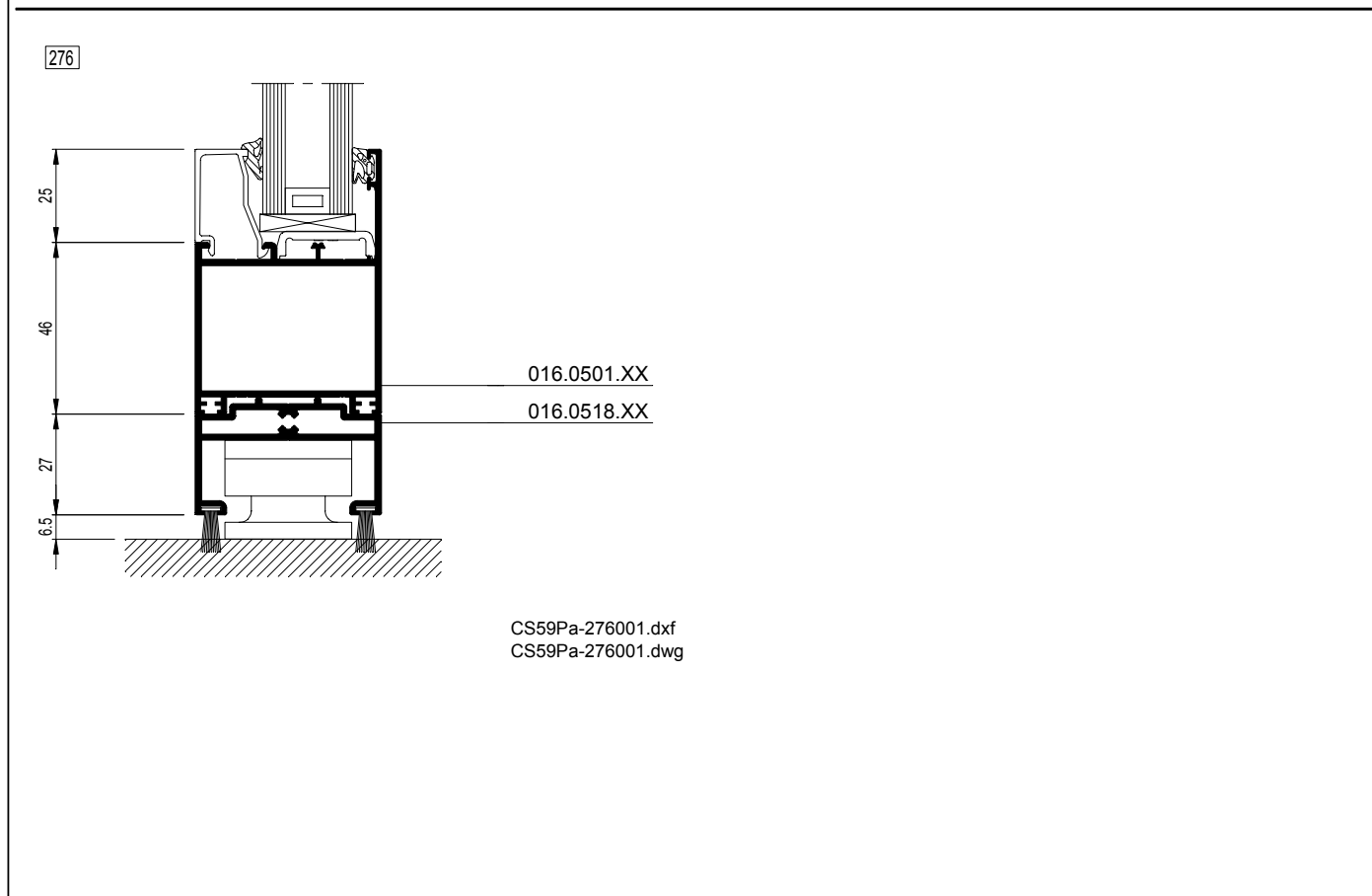
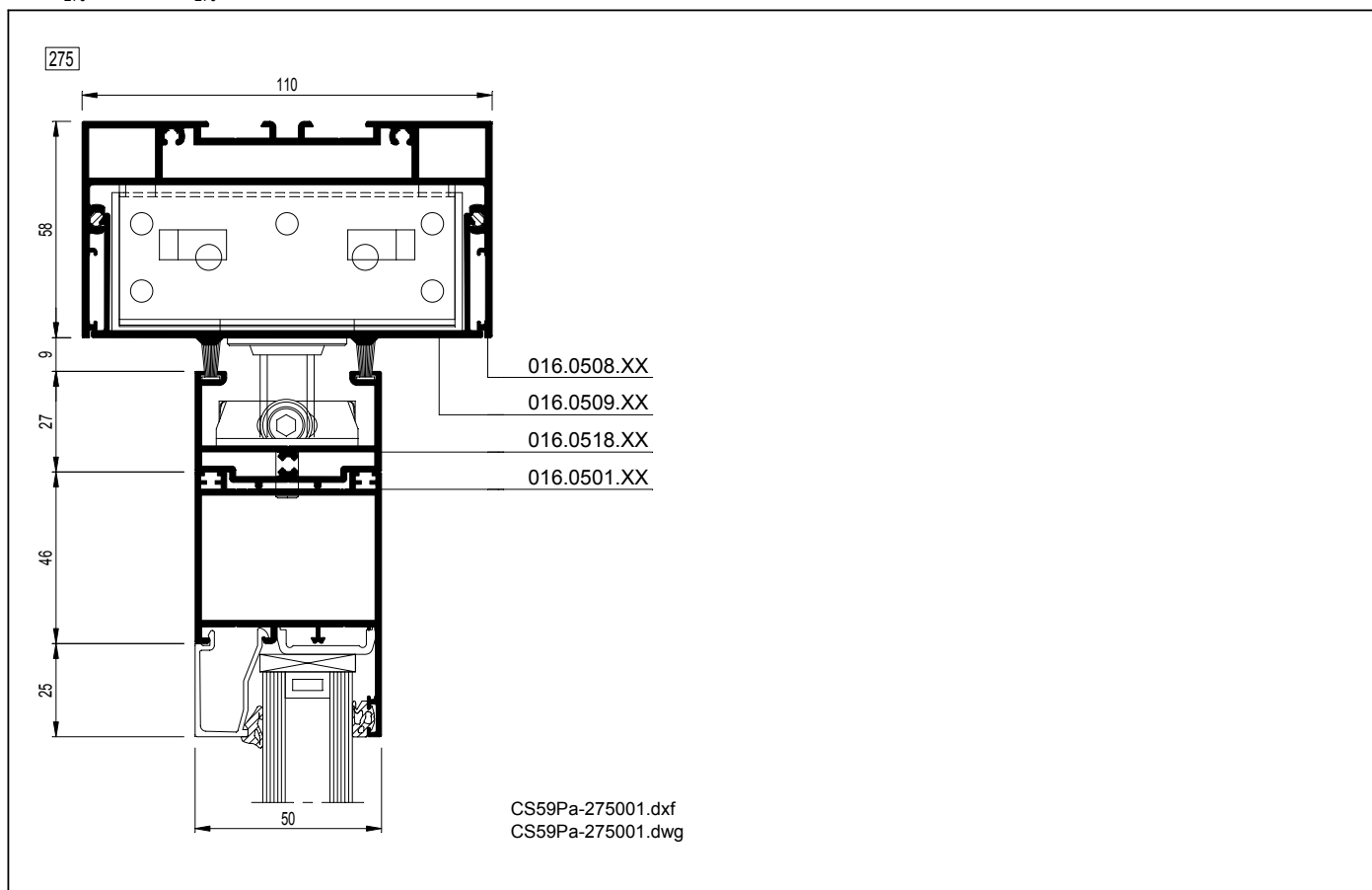
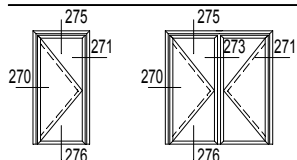

CS 59Pa-SD

Deur zonder vingerbeveiliging - Vloerver deur zonder vingerbeveiliging
Porte sans anti-pince-doigts - Pivot de frein au sol porte sans anti-pince-doigts
Door without finger protection - Floor closer door without finger protection
Einzelne Tür ohne Fingerschutz - Bodentuerschliesser Tür ohne Fingerschutz

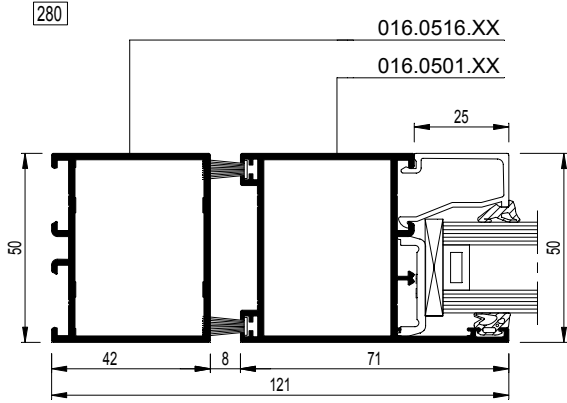
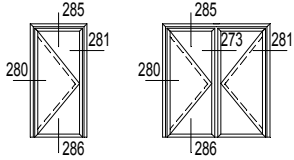

CS59Pa-280001.dxf
CS59Pa-280001.dwg

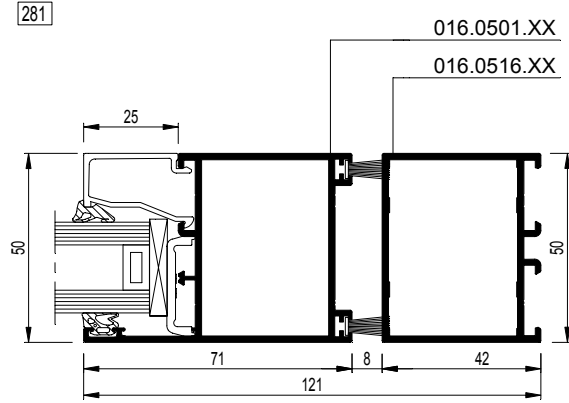

CS59Pa-281001.dxf
CS59Pa-281001.dwg

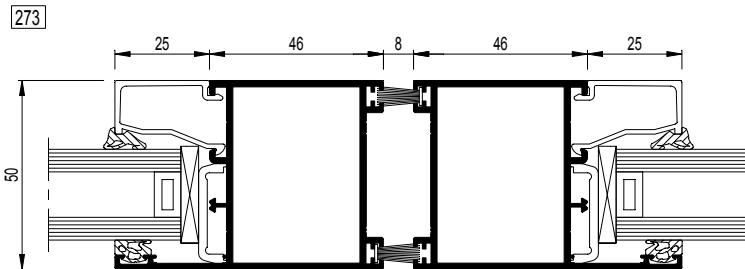

CS59Pa-273001.dxf
CS59Pa-273001.dwg

CS 59Pa-SD

Deur zonder vingerbeveiliging - Vloerveer deur zonder vingerbeveiliging
Porte sans anti-pince-doigts - Pivot de frein au sol porte sans anti-pince-doigts
Door without finger protection - Floor closer door without finger protection
Einzelne Tür ohne Fingerschutz - Bodentuerschliesser Tür ohne Fingerschutz

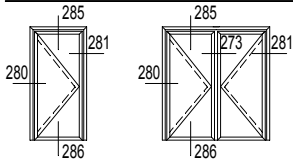

285

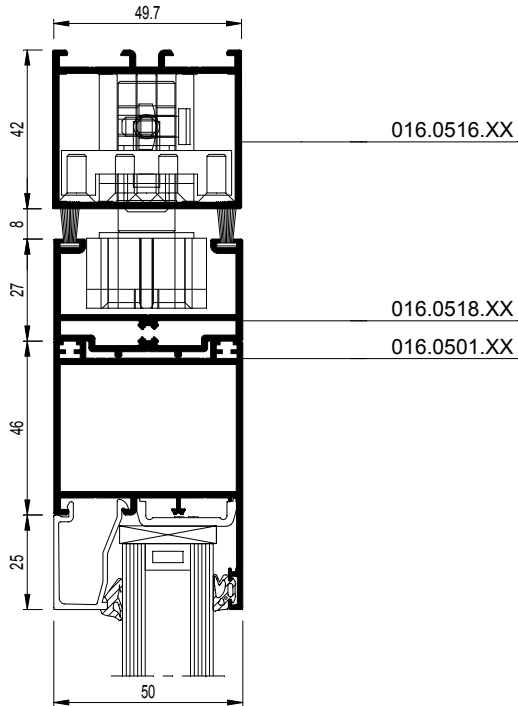

CS59Pa-285001.dxf
CS59Pa-285001.dwg

286

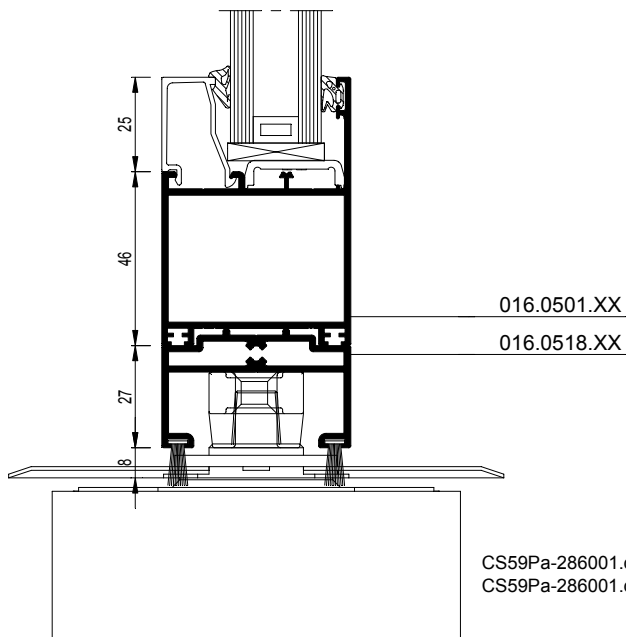

CS59Pa-286001.dxf
CS59Pa-286001.dwg

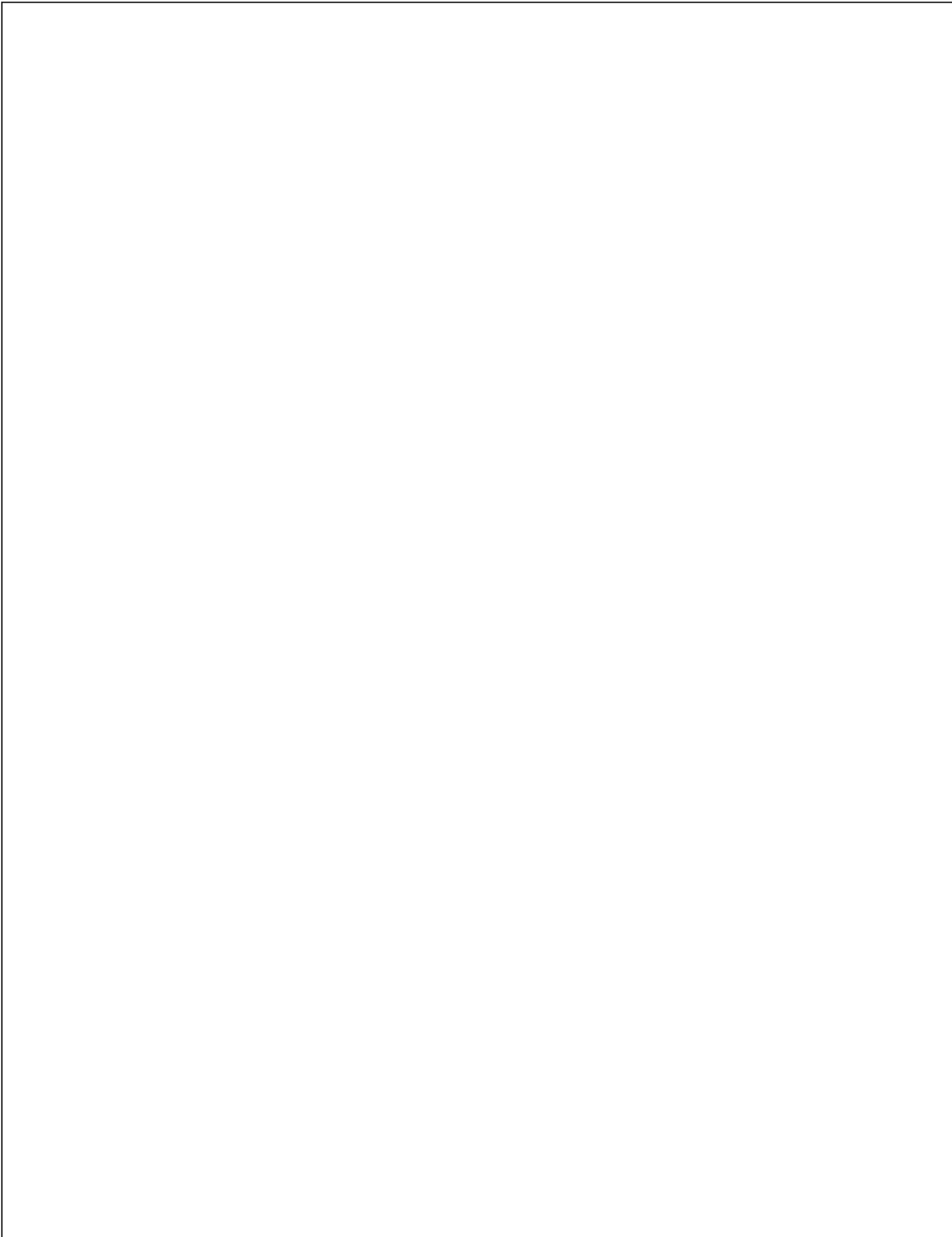

CS 59Pa



CS 59Pa Clampable Door (CS 59Pa-CD)

1 Türen nach innen öffnend

Nach innen öffnende Türen

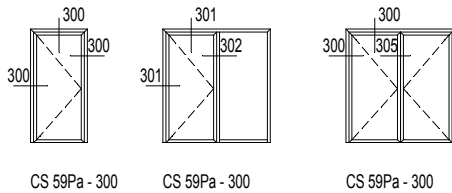

Nach innen öffnende Türen mit rundherum gepresstem Türflügel

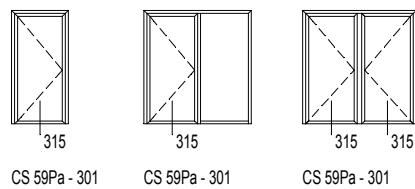

Türen mit T-profilsocket

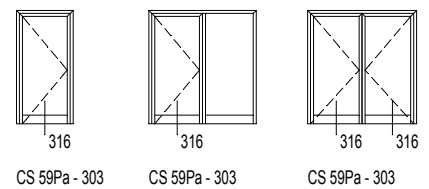

2 Türen nach außen öffnend

Nach außen öffnende Türen

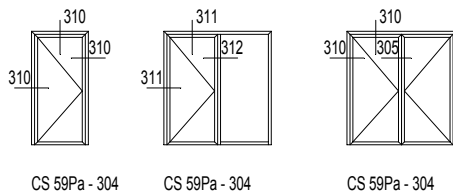

Nach außen öffnende Türen mit rundherum gepresstem Türflügel

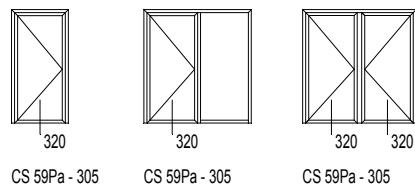

Türen mit T-profilsocket

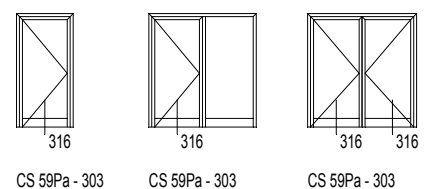

CS 59Pa-CD

Deuren naar binnen draaiend - Naar binnen opengaande deuren
 Portes ouvrant vers l'intérieur - Portes ouvrant vers l'intérieur
 Doors inward opening - Inward opening doors
 Türen nach innen öffnend - Nach innen öffnende Türen

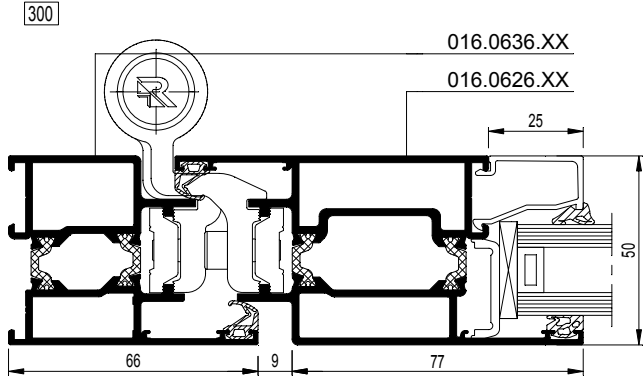
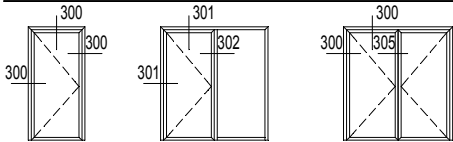

CS59-300001.dxf
 CS59-300001.dwg

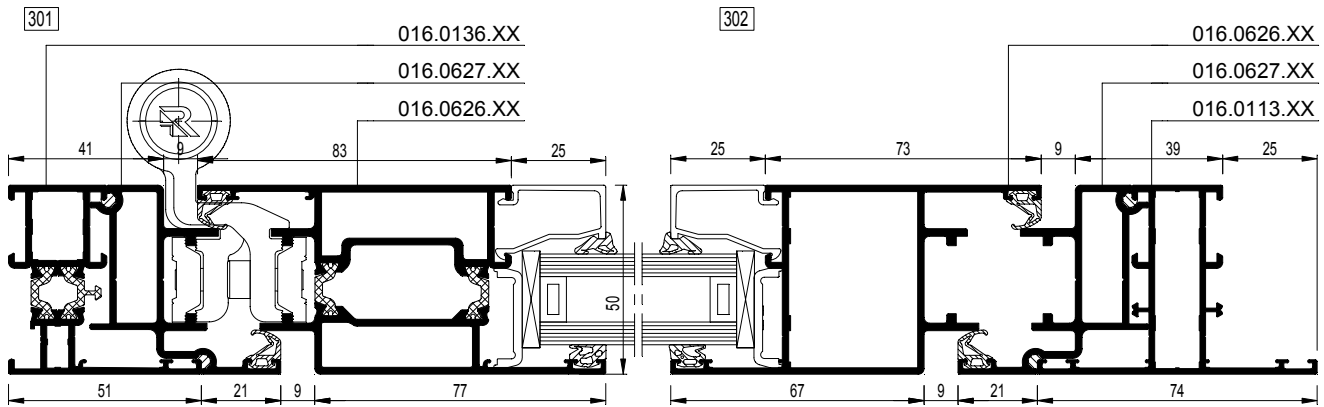

CS59-301001.dxf
 CS59-301001.dwg

CS59-302001.dxf
 CS59-302001.dwg

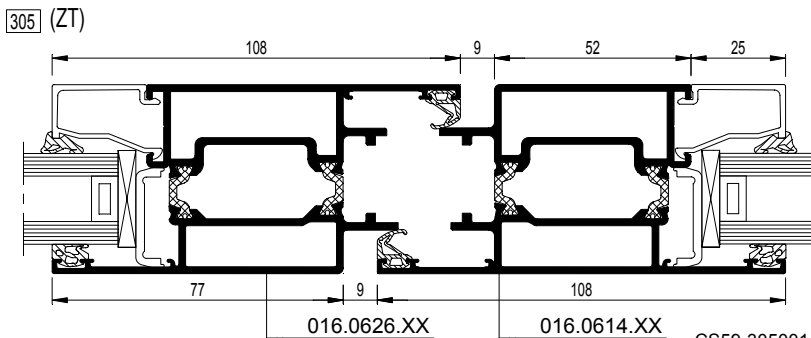

CS59-305001.dxf
 CS59-305001.dwg

CS 59Pa-CD

Deuren naar binnen draaiend - Vleugel rondom geperst
Portes ouvrant vers l'intérieur - Ouvrant serti tout autour
Doors inward opening - Vent crimped all round
Türen nach innen öffnend - Rundherum gepresstem Türflügel

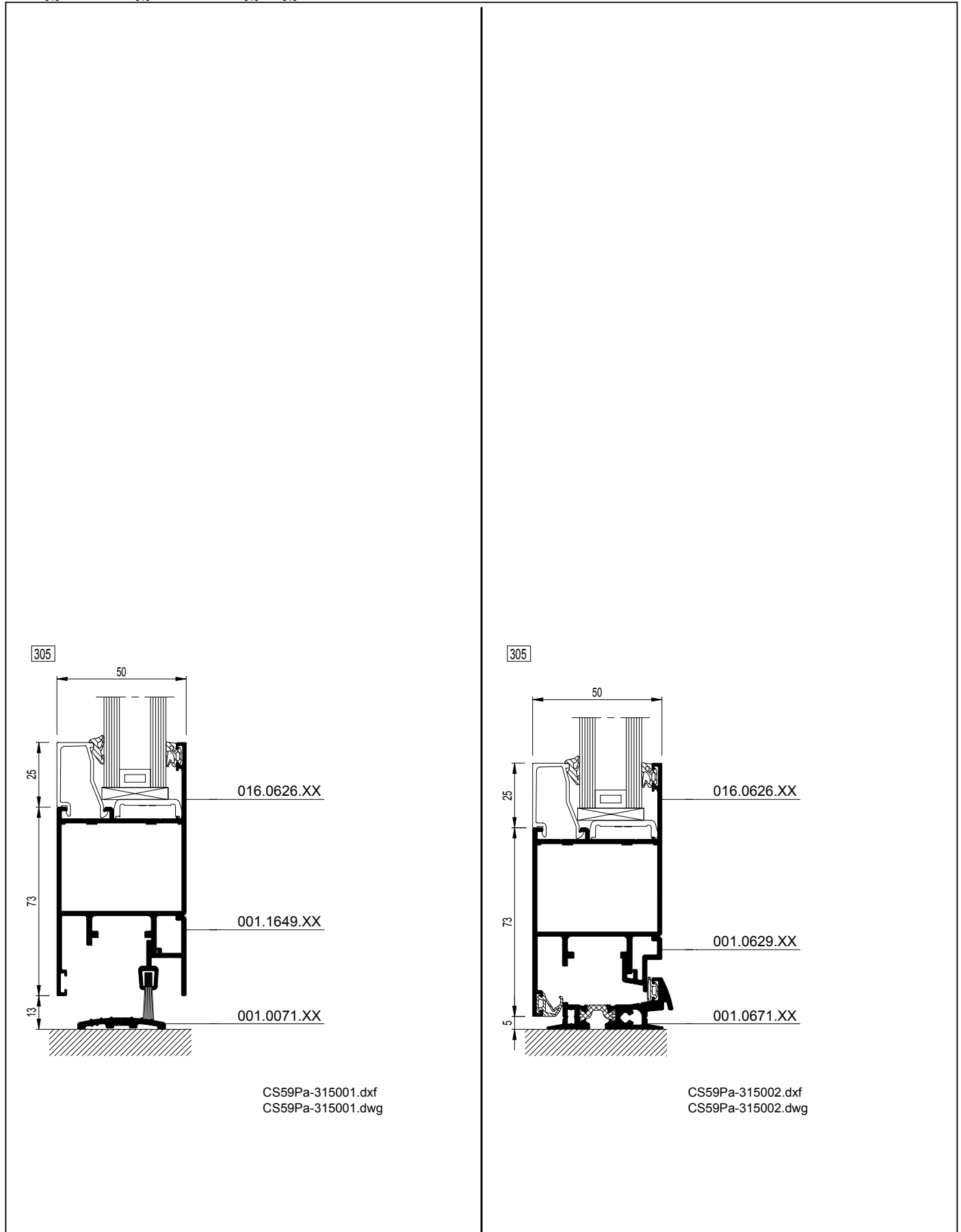
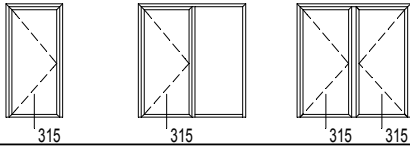

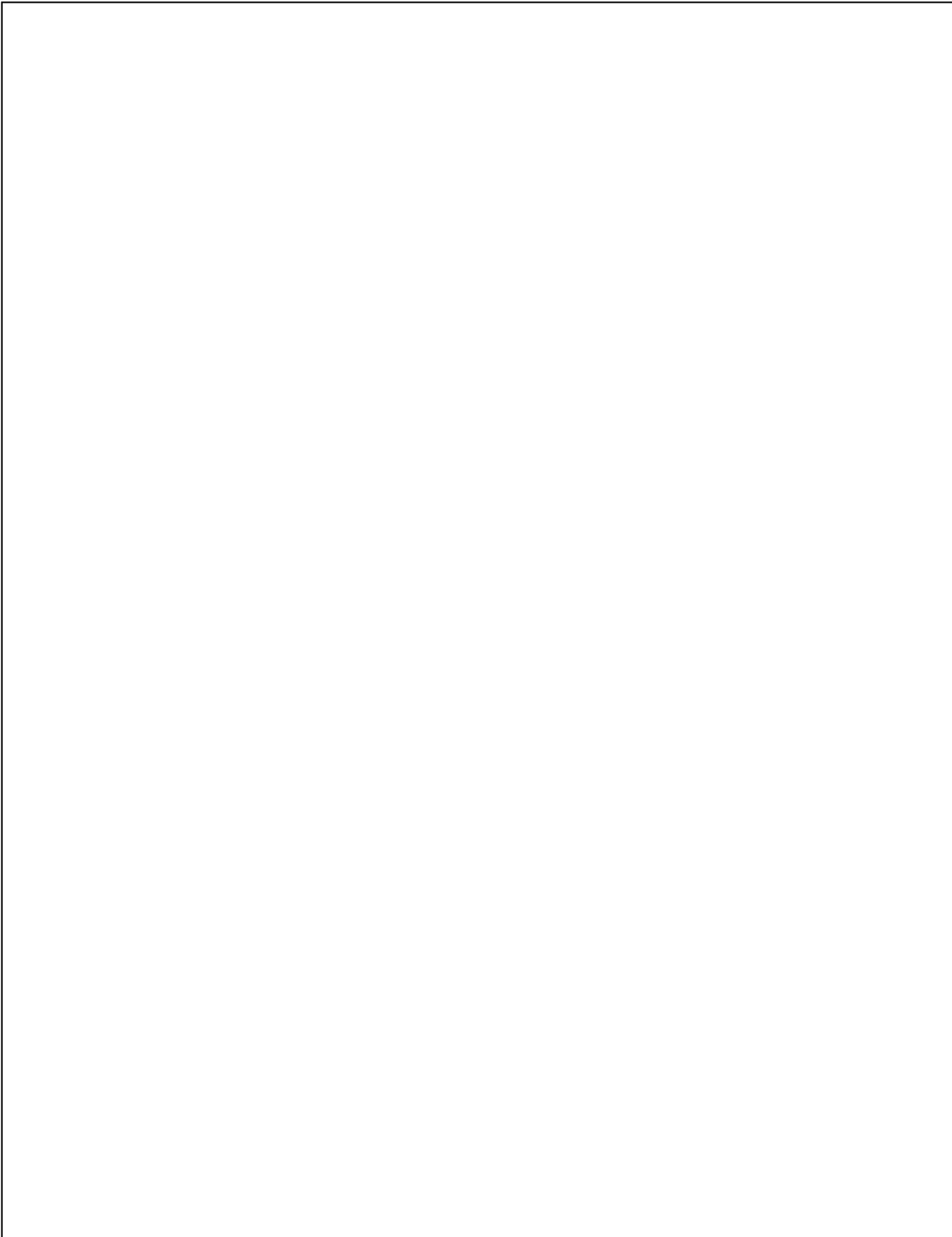

CS 59Pa-CD

Deuren - Deuren met T-profiel
Portes - Portes avec traverse
Doors - Doors with transom-mullion
Türen - Türen mit T-Profilsockel

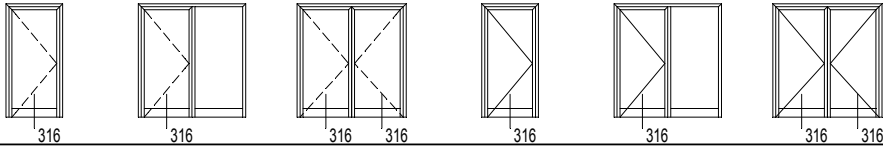

305

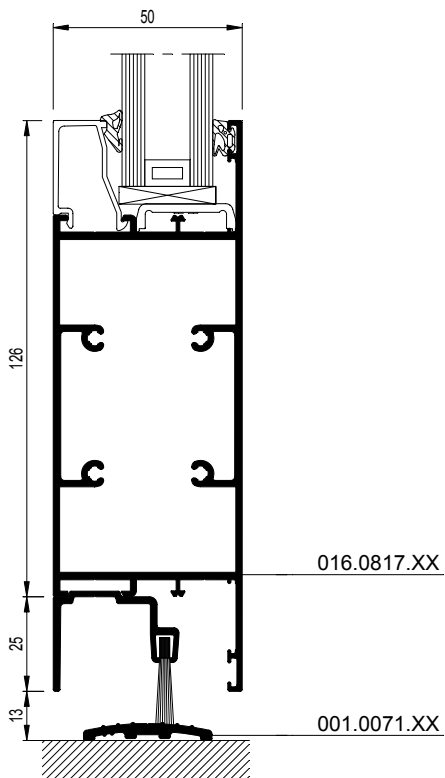

CS59Pa-316001.dxf
CS59Pa-316001.dwg

CS 59Pa-CD

Deuren naar buiten draaiend - Naar buiten opengaande deuren
 Portes ouvrant vers l'extérieur - Portes ouvrant vers l'extérieur
 Doors outward opening - Outward opening doors
 Türen nach außen öffnend - Nach außen öffnende Türen

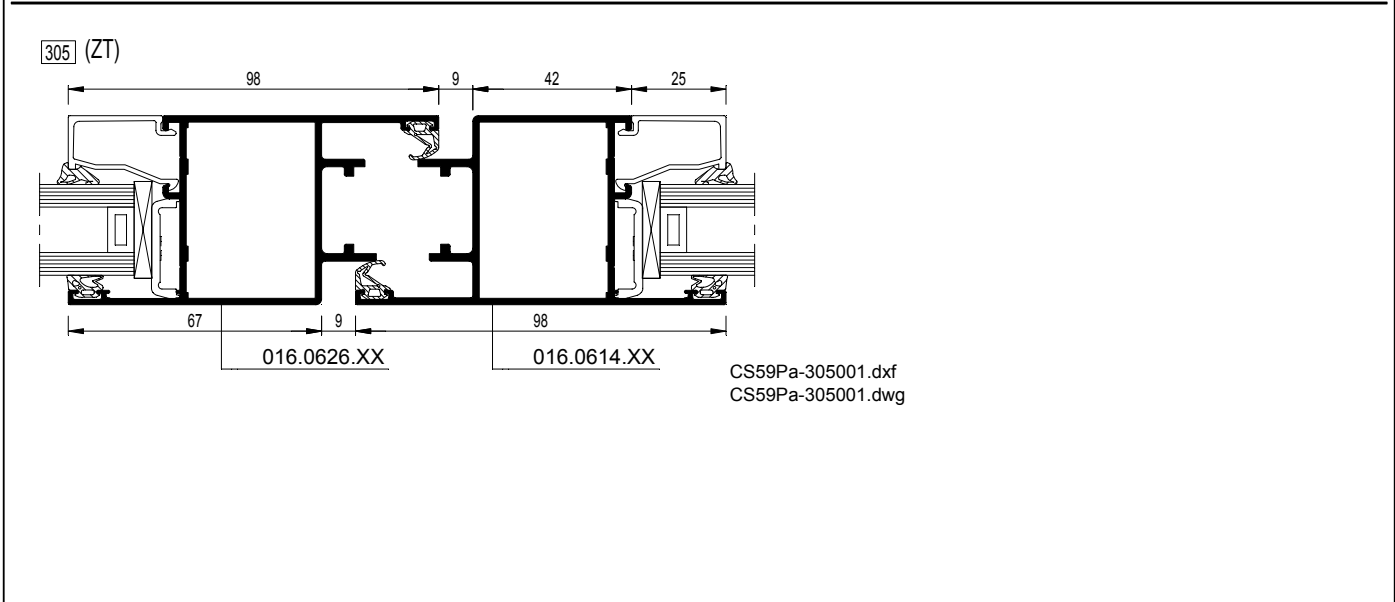
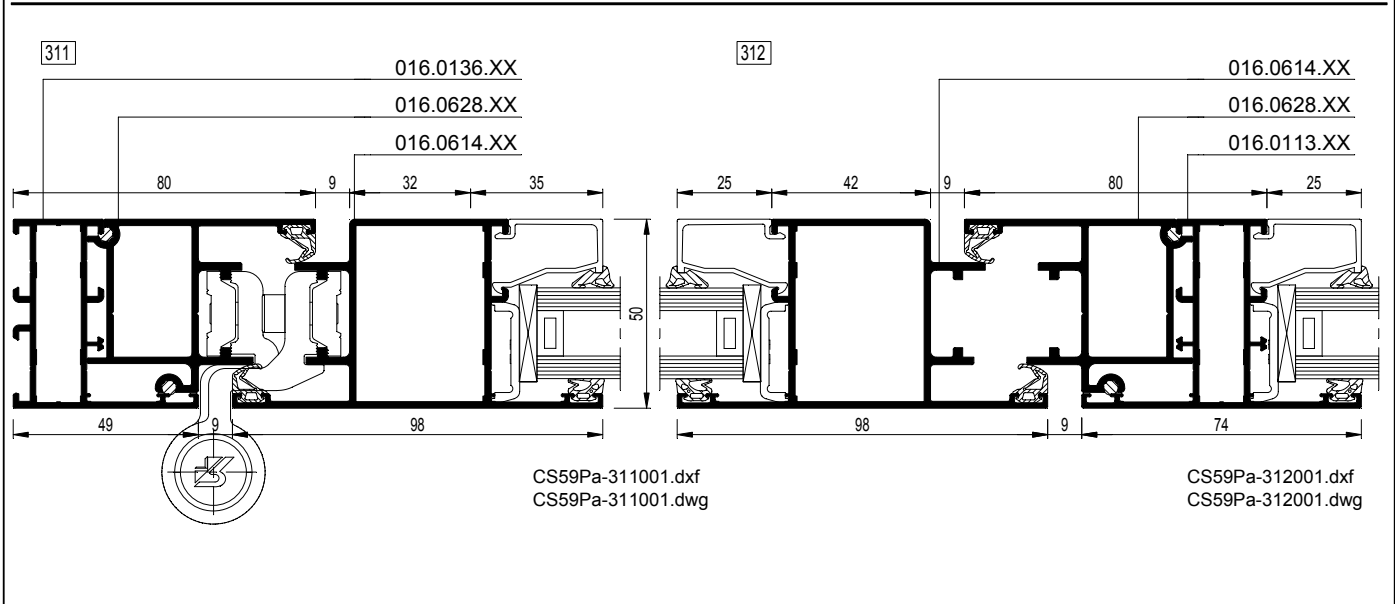
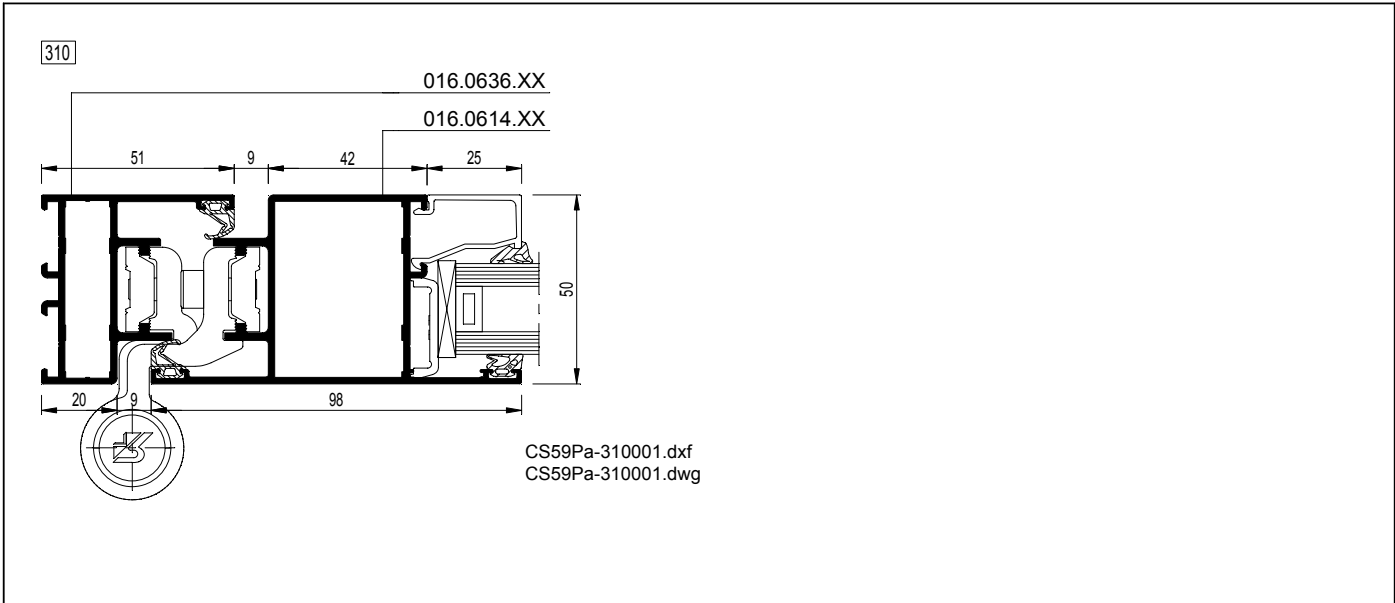
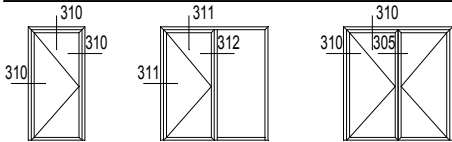

CS 59Pa-CD

Deuren naar buiten draaiend - Vleugel rondom geperst
Portes ouvrant vers l'extérieur - Ouvrant serti tout autour
Doors outward opening - Vent crimped all round
Türen nach außen öffnend - Rundherum gepresstem Türflügel

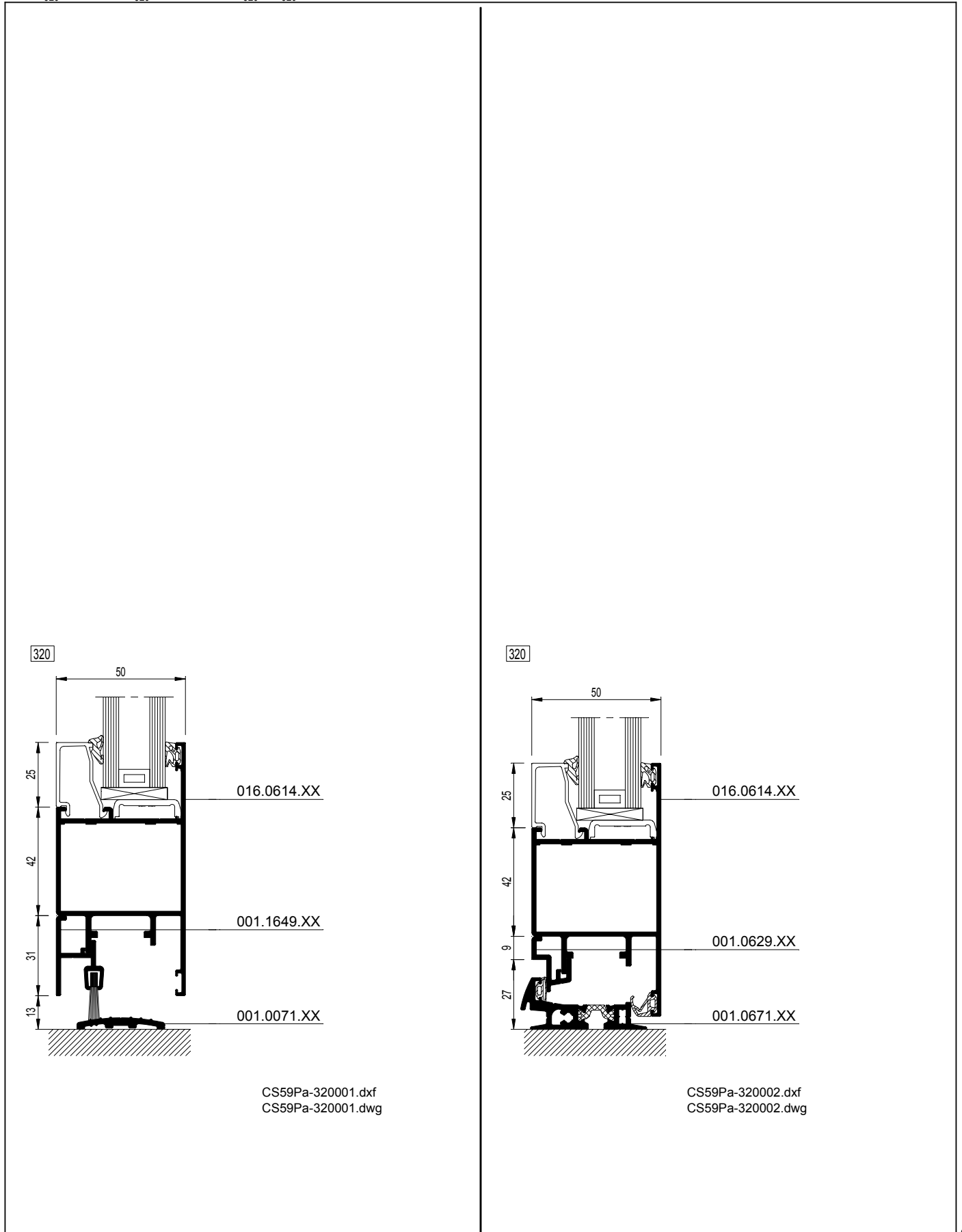
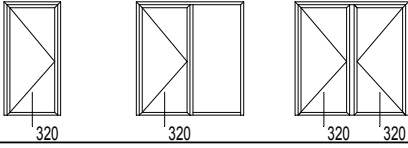

CS59Pa-320001.dxf
CS59Pa-320001.dwg

CS59Pa-320002.dxf
CS59Pa-320002.dwg

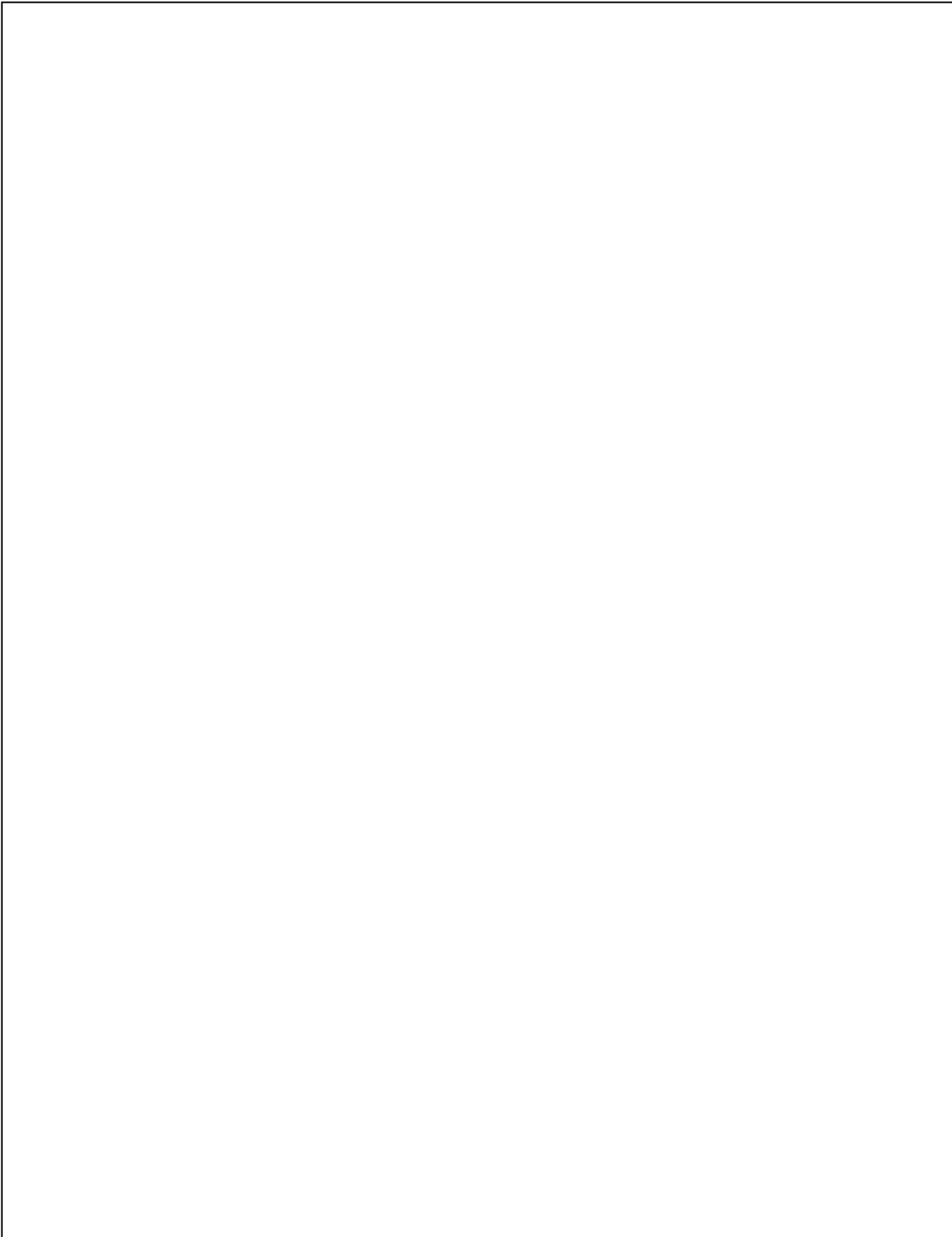



Kombinationen mit anderen Systemen

TP 110
TLS 110
CP 155
TR 200

CS 59Pa - CN002
CS 59Pa - CN002
CS 59Pa - CN003
CS 59Pa - CN005

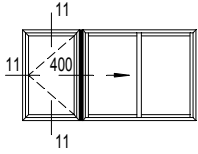

TP 110

400

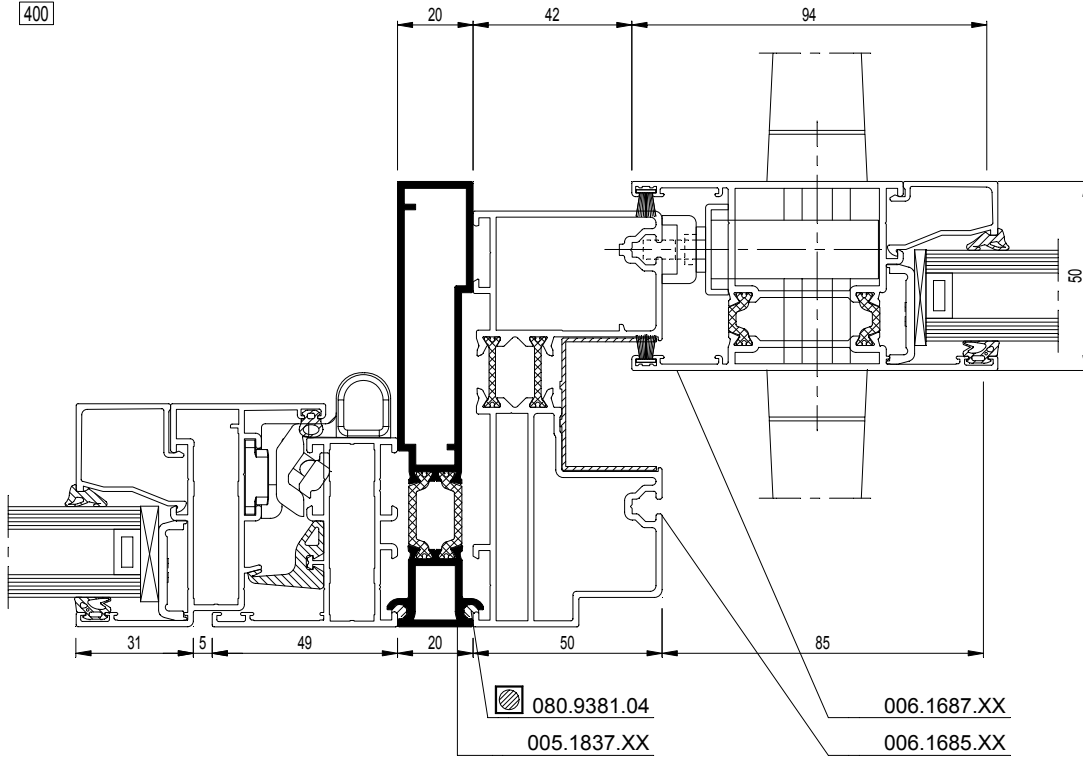

CS59Pa-400001.dxf
 CS59Pa-400001.dwg

TLS 110

400

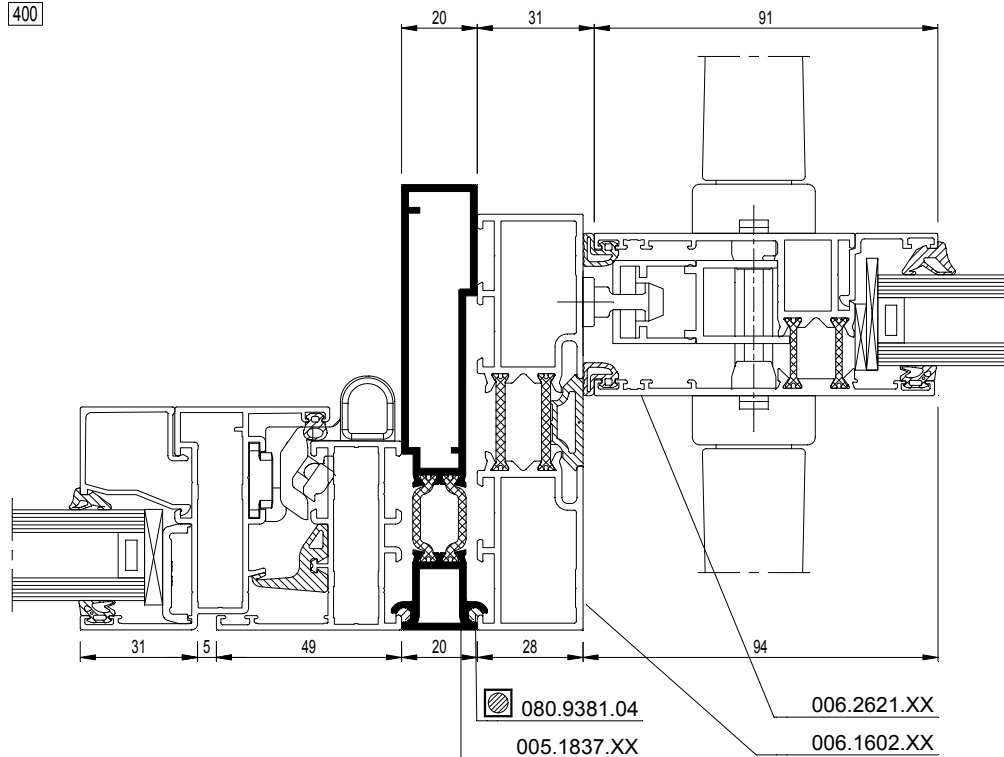

CS59Pa-400002.dxf
 CS59Pa-400002.dwg

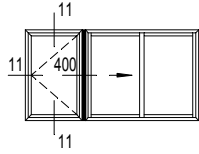

CP 155

400

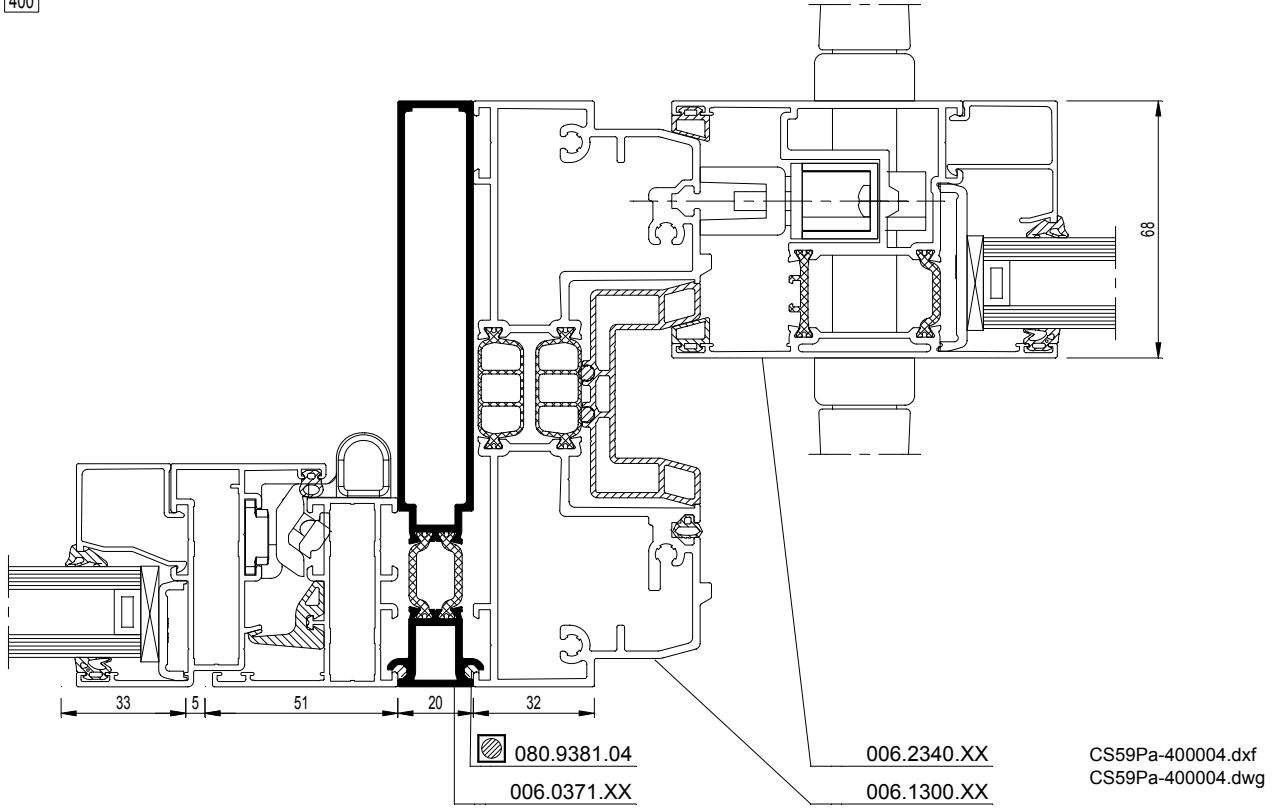

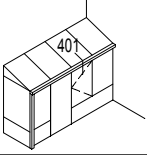

401

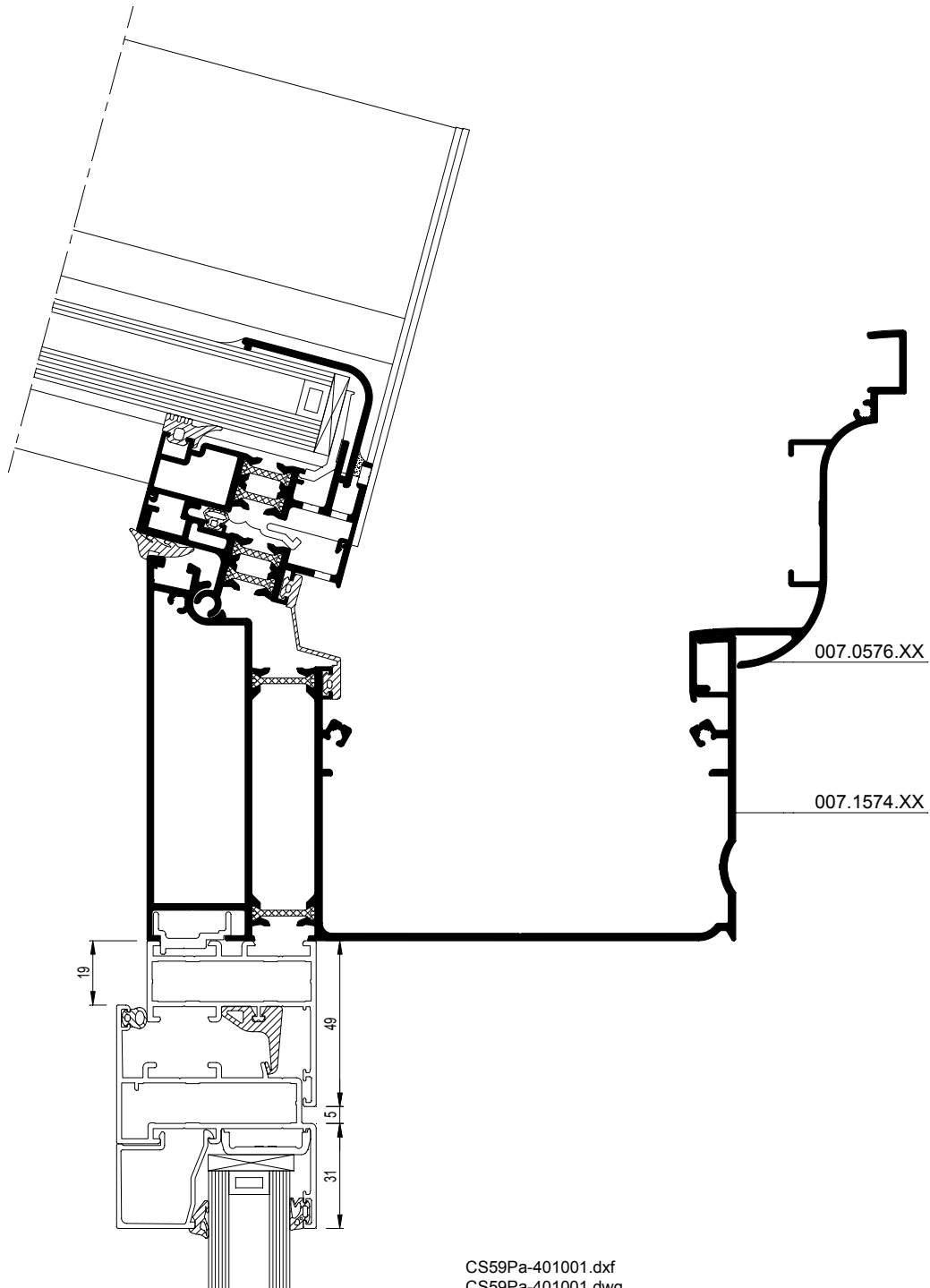

CS59Pa-401001.dxf
CS59Pa-401001.dwg